



AFT Arrow™ 10

Quick Start Guide

Metric Units

Dynamic solutions for a fluid world™



AFT
Applied Flow Technology

AFT ArrowTM

Quick Start Guide

Metric Units

AFT Arrow Version 10
Compressible Pipe Flow Modeling
Published: September 25, 2023



*Dynamic solutions for a fluid world*TM

CAUTION!

AFT Arrow is a sophisticated pipe flow analysis program designed for qualified engineers with experience in pipe flow analysis and should not be used by untrained individuals. AFT Arrow is intended solely as an aid for pipe flow analysis engineers and not as a replacement for other design and analysis methods, including hand calculations and sound engineering judgment. All data generated by AFT Arrow should be independently verified with other engineering methods.

AFT Arrow is designed to be used only by persons who possess a level of knowledge consistent with that obtained in an undergraduate engineering course in the analysis of pipe system fluid mechanics, have been trained in the specialized field of gas dynamics, and are familiar with standard industry practice in pipe flow analysis.

AFT Arrow is intended to be used only within the boundaries of its engineering assumptions. The user should consult the AFT Arrow Help System for a discussion of all engineering assumptions made by AFT Arrow.

Information in this document is subject to change without notice. No part of this Quick Start Guide may be reproduced or transmitted in any form or by any means, electronic or mechanical, for any purpose, without the express written permission of Applied Flow Technology.

© 2023 Applied Flow Technology Corporation All rights reserved.

Printed in the United States of America.

First Printing.

“AFT Arrow”, “Applied Flow Technology”, “Dynamic solutions for a fluid world”, and the AFT logo are trademarks of Applied Flow Technology Corporation.

Excel and Windows are registered trademarks of Microsoft Corporation. Chempak is a trademark of Madison Technical Software, Inc. REFPROP is a trademark of the National Institute of Standards and Technology (NIST). CAESAR II, SmartPlant, CADWorx, and PDS are trademarks of Intergraph Corporation / Hexagon AB. AutoCAD Plant 3D is a trademark of Autodesk, Inc.

Contents

1. Introducing AFT Arrow	1
Modeling capabilities	2
Standard version capabilities	2
Add-on module capabilities (optional)	2
Engineering assumptions in AFT Arrow	3
Thermophysical property data	3
AFT Arrow Primary Windows	4
Workspace	5
Model Data	5
Output	5
Graph Results	5
Input vs. Output	5
2. Orifice CdA & Sonic Choking Example	7
Topics covered	7
Required knowledge	7
Model file	8
Problem statement	8
Step 1. Start AFT Arrow	9
The Workspace window	11
Hiding the Quick Access Panel	12
Step 2. Build the model	13
A. Place a tank	13
Objects and ID numbers	13
Editing on the Workspace	13
B. Place the other junctions	14
C. Draw a pipe between J1 and J2	15
Connecting Junctions with Pipes	15
Reference positive flow direction	18

D. Add the remaining pipe	18
Step 3. Specify Analysis Setup	19
A. Modules	20
B. Fluid Properties	20
C. Pipes and Junctions	21
D. View the final four groups	22
Step 4. Define the model components	23
Object status	23
Showing undefined objects	23
A. Define the J1 Tank	24
Using the tabs in the Properties windows	26
The Inspection feature	27
B. Define other junctions	27
C. Define Pipe P1	28
The Pipe Properties window	28
D. Define Pipe P2	29
E. Check pipes and junctions	30
F. Review Model Data	30
Reviewing input in the Model Data window	30
Step 5. Run the model	31
The output file	32
Step 6. Review the output	33
Step 7. Customize the output	34
Step 8. View the Workspace Layers	36
Step 9. View the Graph Results	39
Step 10. Modify the system	43
Conclusion	44
3. Compressed Air System Analysis Example	45
Topics covered	45
Required knowledge	45
Model file	46
Problem statement	46

Step 1. Specify fluid properties	46
Step 2. Build the model	47
A. Place the pipes and junctions	47
B. Enter the pipe data	48
C. Enter the junction data	51
J1 Tank	51
J2 Compressor	52
J3 - J6 Branches	54
J7 Valve (Tool #1)	54
J8, J9, and J10 Valves (Tool #2, Tool #3, and Tool #4)	55
D. Check if the pipe and junction data is complete	56
Step 3. Create scenarios for the extreme temperature cases	57
Step 4. Set up the Hot Case scenario	58
J1 Tank (Atmosphere)	59
J2 Compressor	59
Pipes P2-P9	59
Step 5. Run the the Hot Case scenario	60
Step 6. Graph the Results	63
Step 7. Set up the Cool Case scenario	66
J1 Tank (Atmosphere)	66
J2 Compressor	67
Pipes P2-P9	67
Step 8. Run the Cool Case scenario	68
Analysis summary	68
Isometric Pipe Drawing Mode	69
4. Natural Gas Burner System Example	75
Topics covered	75
Required knowledge	75
Model file	76
Problem statement	76
Step 1. Specify fluid properties	76
Step 2. Build the model	77

A. Place the pipes and junctions	77
B. Enter the pipe data	77
C. Enter the junction data	79
J1 Tank (Supply Reservoir)	79
J2 Heat Exchanger	79
J8 - J12 Flow Control Valves	79
J13 - J17 Tanks (Burners)	80
J3 - J7 Branches	80
D. Check if the pipe and junction data is complete	80
Step 3. Run the model	80
Step 4. Examine the results	80
Step 5. Manually iterate the heat rate	81
Analysis summary	81

5. AFT Arrow Add-on Modules Examples 83

Topics covered	83
Required knowledge	84
Model files	84
GSC Problem statement	84
GSC Step 1. Specify fluid properties	85
GSC Step 2. Build the model	85
A. Place the pipes and junctions	85
B. Enter the pipe data	86
C. Enter the junction data	87
J1 and J2 Tanks	87
J106 - J108 and J206 - J208 Assigned Flows	88
J102, J105, J202, and J205 Bends	88
J101, J103, J104, J201, J203, and J204 Tees	88
D. Check if the pipe and junction data is complete	88
GSC Step 3. Create a scenario for the GSC Case	89
GSC Step 4. Activate the GSC Module	89
GSC Step 5. Goal Seek and Control group	90
GSC Step 6. Add the variables	90

Linking variables	92
GSC Step 7. Add a goal	93
Define a group	93
Add a Group Max/Min goal	94
GSC Step 8. Run the model	95
GSC Step 9. Examine the results	97
GSC analysis summary	97
XTS Problem statement	98
XTS Step 1. Activate the XTS Module	98
XTS Step 2. Define the simulation duration	99
XTS Step 3. Specify fluid properties	100
XTS Step 4. Build the model	101
A. Place the pipes and junctions	101
B. Enter the pipe data	101
C. Enter the junction data	102
J1 Assigned Pressure	102
J2 Compressor	102
J3 Heat Exchanger	102
J4 Valve	103
J5 Tank	103
XTS Step 5. Set Up the Compressor Transient	104
XTS Step 6. Run the model	105
XTS Step 7. Examine Transient Results	106
6. Other AFT Arrow Capabilities	113
Index	119

Introducing AFT Arrow

Welcome to AFT Arrow, Applied Flow Technology's powerful compressible pipe flow modeling tool. With AFT Arrow you can model compressible flow in complex pipe networks, and include the complicating effects of real gas behavior, heat transfer, gas mixing, and sonic choking at one or more locations. In addition, it includes steam property calculation from respected sources such as the ASME Steam Tables. These capabilities will allow you to properly understand the behavior of your gas system.

AFT Arrow performs a complete mass, momentum, and energy balance on your pipe system. It implements a sophisticated solution engine that marches down pipes, offering superior accuracy to commonly used lumped methods.

AFT Arrow has three available Add-on Modules for purchase which extend the modeling capabilities into new areas.

- The Goal Seek & Control (GSC) module allows the engineer to perform multivariable goal seeking and simulate control system functions.
- The Extended Time Simulation (XTS) module allows the engineer to model time-varying system behavior via a series of steady-state snapshots.
- The Automated Network Sizing (ANS) module automates the process of sizing pipes and ducts in a complex network based on design requirements, such as maximum pressure or minimum flow, to reduce cost or weight.

Modeling capabilities

Standard version capabilities

- Open and closed (recirculating) systems
- Network systems that branch or loop, with no limit on the number of loops
- Pressure-driven systems
- Compressor or fan-driven systems, including multiple compressors/fans in parallel or in series
- Compressors/fans with variable speed, controlled pressure, controlled flow, and a fixed compression ratio
- Systems with pressure and/or flow control valves
- Systems with valves closed and/or compressors/fans turned off
- Heat transfer analysis and system energy balance
- Systems with non-ideal gases
- Systems that experience sonic choking, including multiple sonic choking points
- Systems with non-reacting flow stream mixing with NIST REFPROP (or with optional Chempak)
- Systems with elevation changes or rotation such as in turbomachinery

Add-on module capabilities (optional)

- Multivariable goal seeking and control simulation (GSC)
- Time-varying system modeling (XTS)
- Valves opening and closing over time (XTS)
- Compressors/fans starting and stopping over time (XTS)
- Automated design of piping networks (ANS)

AFT Arrow provides hundreds of standard loss values from handbook sources for pipe system components, and also allows the engineer to

enter their own loss data. Variable loss models that depend on flow are supported.

AFT Arrow provides two independent solution methods (length and Mach number march) that can be run individually or in combination with each other to allow flexibility and cross-verification of results. In addition, AFT Arrow offers two lumped methods (adiabatic and isothermal) that offer improved computation speed with a slight loss in accuracy. Sonic capabilities allow modeling of high velocity conditions such as in relief systems.

AFT Arrow allows you to change the gravitational acceleration of the system, a feature useful for aerospace vehicle applications or pipe systems that are designed for extraterrestrial environments.

Engineering assumptions in AFT Arrow

AFT Arrow is based on the following fundamental fluid mechanics assumptions:

- Compressible flow
- Steady-state conditions (XTS Module consists of steady snapshots)
- One-dimensional flow
- System is fluid-full
- All gases are superheated (single phase)
- No chemical reactions
- No supersonic flow in the system

Thermophysical property data

AFT Arrow offers several sources from which thermophysical properties can be derived:

- ASME Steam Tables - Properties are calculated with the equations of state from the IAPWS Industrial Formulation (1997), also used to generate the ASME steam tables.

4 AFT Arrow™ 10 Quick Start Guide

- Chempak™ - Optional add-on for purchase which contains data for approximately 600 gases and supports user-specified fluid mixtures. Chempak is licensed from Madison Technical Software.
- NIST REFPROP - The Reference Fluid Thermodynamic and Transport Properties Database is licensed from the National Institute of Standards and Technology (NIST) where properties for approximately 150 fluids are calculated via equations of state. REFPROP supports user-specified fluid mixtures.
- AFT Standard - Common fluids from various industry standard sources have been curve fit to optimize calculation speed.
- User Library Fluid - A custom fluid can be saved to the User Library for repeated use in the future.

NIST REFPROP and Chempak support gas mixing in two forms. First, users can create their own mixtures. These are called *static mixtures* and are defined before the model is run. Second, as flow streams of different composition mix, an entirely new gas mixture results. Its composition depends on the composition of the incoming streams as well as the relative flow rates. AFT Arrow updates the composition of this new mixture as the simulation progresses. For this reason, these mixtures are referred to as *dynamic mixtures*. AFT Arrow will treat all gas mixtures as being non-reacting.

AFT Arrow can model a large range of gases including steam, natural gas, air, chemical, and petrochemical process gases. Support for real gases is offered through several generalized equation of state models, the ASME Steam Tables, the NIST REFPROP fluid library, or the optional Chempak add-on fluid library.

AFT Arrow Primary Windows

AFT Arrow has several Primary Windows that work in an integrated fashion. Each is located on a separate, moveable tab. You work exclusively from one of these windows at all times. For this reason, they are referred to as *Primary Windows*.

Workspace

The Workspace Primary Window is where the user creates the graphical representation of the system. Engineering data is input on pipe and junction property windows which are opened by double-clicking the objects.

The Workspace Layers are also located on this Primary Window and allow the user to display both input and output data superimposed on the pipe system schematic.

Model Data

The Model Data Primary Window summarizes the engineering input data from the Workspace into categorized tables. This allows for easy review of the system inputs, and double clicking cells will open the pipe or junction properties for quick editing.

Output

The Output Primary Window offers a powerful and diverse range of features for reviewing analysis results which are organized into categorized tables and lists. The Output allows the user to easily compare multiple design scenarios with color coded rows, details errors or design requirement violations, and prepare the results for documentation.

Graph Results

The Graph Results Primary Window allows the user to create a wide array of graphs with various parameters which are integral to gaining a deeper understanding of the pipe system's behavior. The user can adjust various formatting settings such as axis ranges, labels, colors, and create dual y-axis or stacked graphs. The settings can be saved into templates called Graph List Items so that the graphs can be easily reproduced.

Input vs. Output

Table 1.1 summarizes how each Primary Window relates to input and output data. The Workspace can display output data by using Workspace Layers after the simulation has been run.

Table 1.1 Primary Window Input vs. Output Data

Primary Window	Can Display Input	Can Display Output
Workspace	✓	✓
Model Data	✓	
Output		✓
Graph Results		✓

Note: AFT Arrow supports multiple monitors. You can click and drag any of the Primary Window tabs off of the main AFT Arrow window, where it can then be moved anywhere on the screen, including onto a second monitor. To add the Primary Window back to the main AFT Arrow program window bar, simply close the Primary Window.

Note: To ensure that your results are the same as those presented in this documentation, these examples should be run using default AFT settings, unless you are specifically instructed to do otherwise.

Orifice CdA & Sonic Choking Example

This example demonstrates a sample calculation to determine the maximum flow through a system where sonic choking occurs.

Topics covered

- Model building basics
- Entering Pipe and Junction data
- Specifying Analysis Setup
- Specifying Output Control
- Using Workspace Layers
- Graphing results

Required knowledge

No prior knowledge is required for this example.

Model file

This example is intended to be built from scratch to help familiarize yourself with the steps to define a complete model in AFT Arrow. For reference purposes only, the completed example model file can be found in the Examples folder as part of the AFT Arrow installation:

C:\AFT Products\AFT Arrow 10\Examples

- *Metric - Orifice CdA and Sonic Choking.aro*

Problem statement

For this problem, steam flows from one tank to another, through an orifice.

The first pipe from the inlet tank to the orifice is 3 meters long and the second pipe leading from the orifice to the discharge tank is 6 meters long. Both pipes are Steel - ANSI, 2 inch, STD (schedule 40), and they are very well insulated (adiabatic).

The inlet tank has a pressure of 16 barG, and a temperature of 260 deg. C. The discharge tank has a pressure of 0 barG. The elevation of both tanks is 0 meters.

The orifice at the end of the first pipe has an area of 20 cm² and a K Factor of 10.

Determine the following:

1. What is the flowrate through the system?
2. What is the sonic stagnation pressure at the exit?
3. At the maximum flow, what is the sonic area at the orifice? At the discharge tank?

Step 1. Start AFT Arrow

- To start AFT Arrow, open the all applications list in the Windows Start Menu, expand the AFT Arrow 10 folder, and choose AFT Arrow 10. This refers to the standard menu items created by a standard installation; you may have chosen to specify a different installation location.

As AFT Arrow starts, the Arrow Startup window appears, as shown in Figure 2.1. This window provides you with several options you can choose before you start building a model.

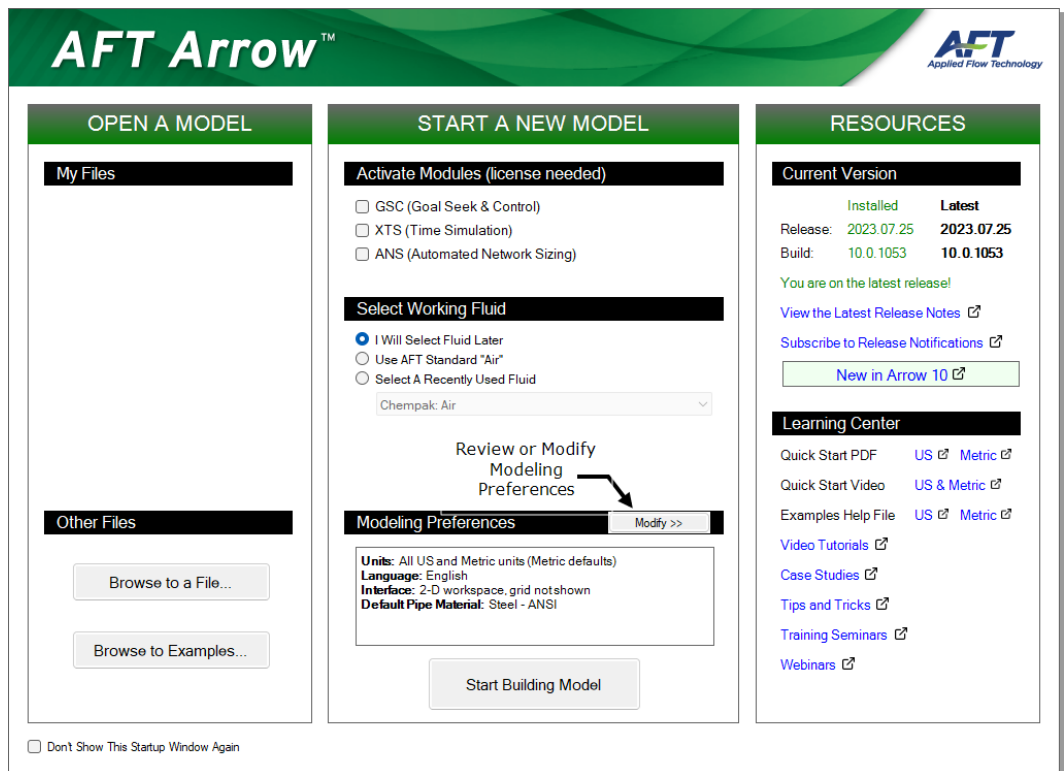

Figure 2.1 Startup Window with Modeling Preferences Collapsed

Some of the actions available are:

10 AFT Arrow™ 10 Quick Start Guide

- Open a recent model, browse to a model, or browse to an example
- Activate an Add-on Module
- Select AFT Standard Air or a recently used fluid
- Review or modify Modeling Preferences: select a Unit System, filter units, choose a Grid Style, select a Default Pipe Material, and more
- Access other Resources such as Help Files and Video Tutorials

If this is the first time that you have started AFT Arrow, Modeling Preferences will be expanded in the middle section of the Startup Window, as shown in Figure 2.2. If this is not the first time that you have started AFT Arrow, the Startup Window will appear with Modeling Preferences collapsed, as shown in Figure 2.1.

When collapsed, you can view your current Modeling Preferences at the bottom of the Start a New Model section. To further review or adjust your preferences, click the Modify button (see Figure 2.1).

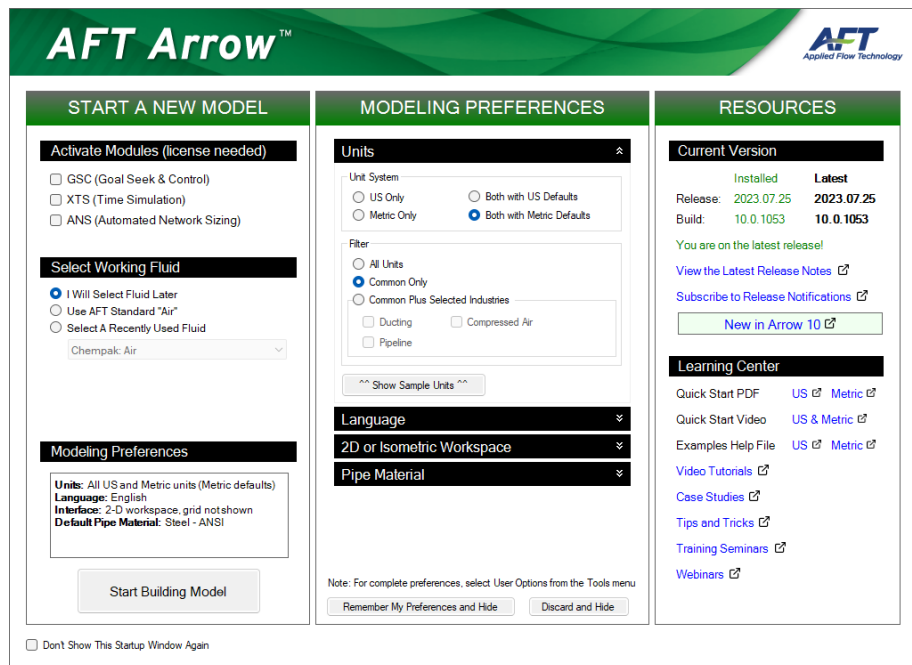

Figure 2.2 Startup Window with Modeling Preferences Expanded

- **With Modeling Preferences expanded, as in Figure 2.2, select Both with Metric Defaults under Unit System.** The Filter section can be used to limit the number of units that are shown in the interface.

The Common Plus Selected Industries option adds units from the industries you select. You can use the Show Sample Units option to see the model units based on your selections. After modifying your Modeling Preferences, click Remember My Preferences and Hide.

- **Click Start Building Model.**

The Workspace window is shown initially, as seen in Figure 2.3. The tabs in the AFT Arrow window represent the Primary Windows. Each Primary Window contains its own toolbar that is displayed directly beneath the Primary Window tabs.

The Workspace window

The Workspace window is the Primary Window for building your model. This window has three main areas: the Toolbox, the Quick Access Panel, and the Workspace itself. The Toolbox consists of the object icons on the far left. The Quick Access Panel is on the far right and gives easy access to the Scenario Manager, object Properties, and Workspace Layers.

12 AFT Arrow™ 10 Quick Start Guide

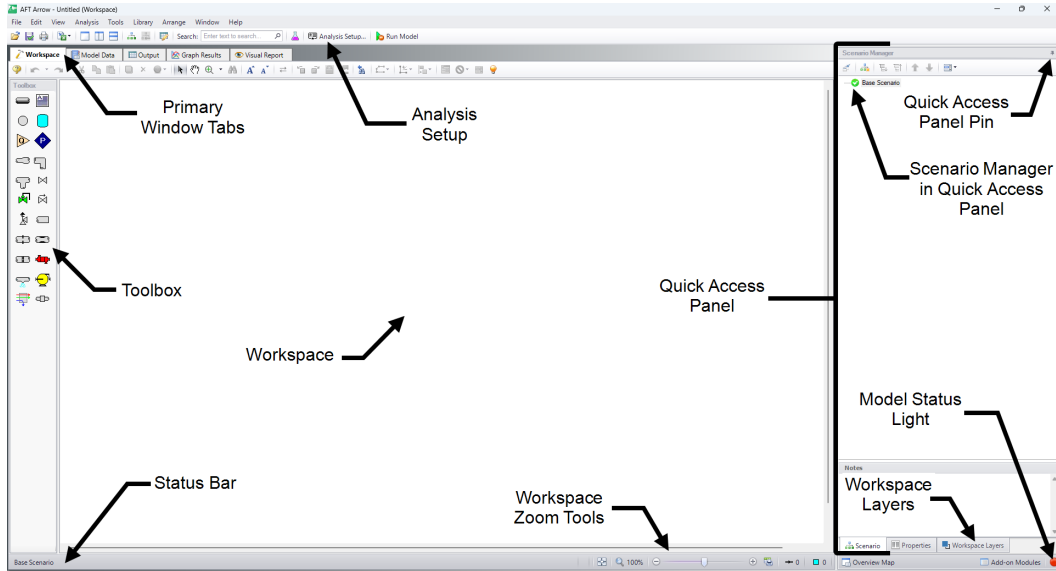

Figure 2.3 The Workspace Primay Window

You will build your model on the Workspace using the Toolbox. The Pipe Drawing tool on the upper-left is used to draw new pipes on the Workspace. The Annotation tool beside it allows you to create annotations and auxiliary graphics.

Below the two drawing tools are the different types of junctions available in AFT Arrow. Junctions connect pipes and also influence the pressure or flow behavior of the pipe system. Drag and drop any of the junction icons from the Toolbox to add them to the Workspace.

Holding your mouse pointer over a Toolbox icon identifies the tool's function.

Hiding the Quick Access Panel

By default, the Quick Access Panel is pinned to the Workspace window so it is always displayed. The Quick Access Panel can be unpinned so it is only displayed when the mouse is moved over a tab displayed on the right edge of the Workspace window. Unpin the Quick Access Panel by clicking on the pin icon displayed in the top right corner of the Quick Access Panel (see Figure 2.3). The Quick Access Panel will be pinned for the remainder of the examples in this guide.

Step 2. Build the model

To lay out this example model, you will place several junctions on the Workspace. Then, you will connect the junctions with pipes.

A. Place a tank

- **To start, drag a Tank junction from the Toolbox** and drop it on the Workspace. Figure 2.3a shows the Workspace with one tank.

Objects and ID numbers

Items placed on the Workspace are called *objects*. AFT Arrow uses three types of objects: *pipes*, *junctions*, and *annotations*.

All pipe and junction objects on the Workspace have an associated ID number. Junctions are prefixed with the letter J, and pipes are prefixed with the letter P. You can assign a name in the object's Properties window, and the visibility of both the name and ID number can be controlled through the use of Workspace Layers. You can also drag the ID number/name text to a different location to improve visibility.

The tank you have created on the Workspace will take on the default ID number of 1. You can change this to any desired integer between 1 and 99,999 that is not already assigned.

Editing on the Workspace

You can move junctions on the Workspace to new locations. You can also cut, copy, paste, and duplicate junctions from the Edit menu or using keyboard shortcuts. Undo is available for most arrangement actions on the Workspace.

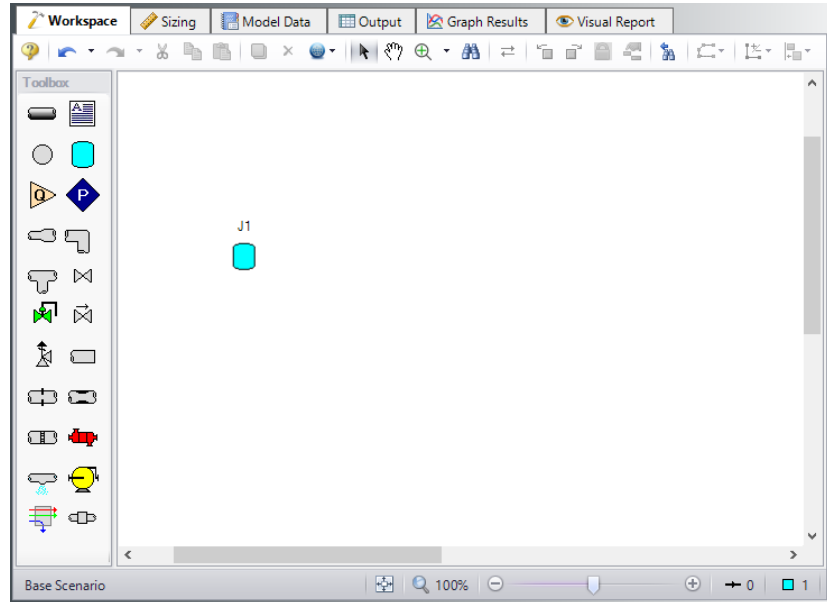

Figure 2.3a Walk through model with the first junction placed

B. Place the other junctions

Drag an Orifice junction from the Toolbox and drop it somewhere to the right of the Tank junction (see Figure 2.3b).

If a new junction type you want to add already exists on the Workspace, you have the option of duplicating that junction. You do this by choosing Duplicate from the Edit menu or by using CTRL+D. Either duplicate the first tank, or drag a new Tank junction onto the Workspace. Place the new tank to the right of the Orifice junction (see Figure 2.3b).

Note: The relative location of objects in AFT Arrow is not important. Pipe lengths and junction elevations are defined through property windows. The relative object locations on the Workspace establish the connectivity of the objects but have *no bearing on the actual length or elevation relationships*. The Isometric Pipe Drawing Mode (see Chapter 3) can be used to visually represent the three-dimensional nature of a system.

Even if the icons do not line up exactly, the results will not change. However, your model may have a better appearance if the icons do line up. You can align the icons from the Arrange menu using the Align feature.

Your model should now appear similar to that shown in Figure 2.3b.

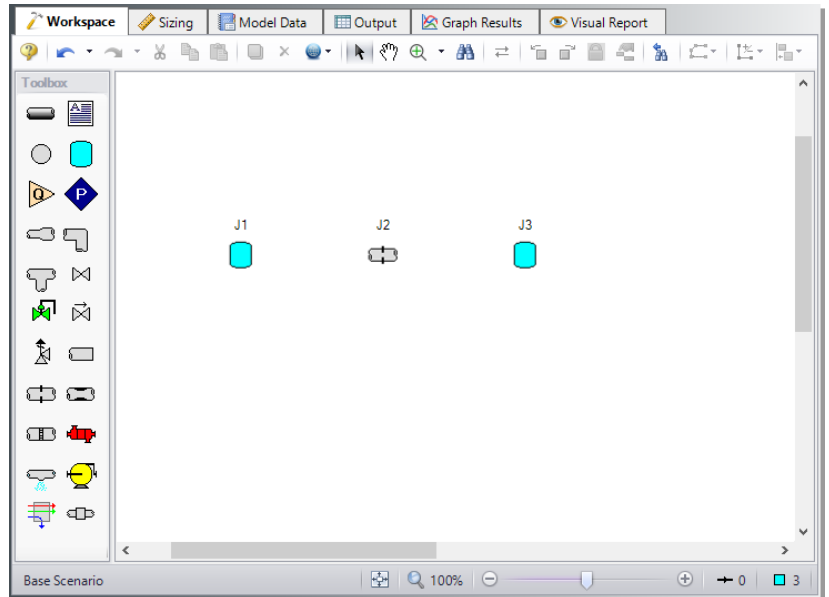

Figure 2.3b Walk through model with all junctions placed

- **Before continuing, save your work.** Press CTRL+S, use the Save button on the Common Toolbar, or go to the File menu and select Save. AFT Arrow models use the *.aro file extension.

C. Draw a pipe between J1 and J2

Now that you have all of the junctions placed, you need to connect them with pipes.

Connecting Junctions with Pipes

- **To create a pipe,** click the Pipe Drawing Tool icon on the Toolbox. The mouse pointer will change to a crosshair when you move it over the

16 AFT Arrow™ 10 Quick Start Guide

Workspace. Click and drag to draw a pipe below the junctions, similar to that shown in Figure 2.3c.

The pipe object on the Workspace has an ID number (P1) that is shown near the center of the pipe.

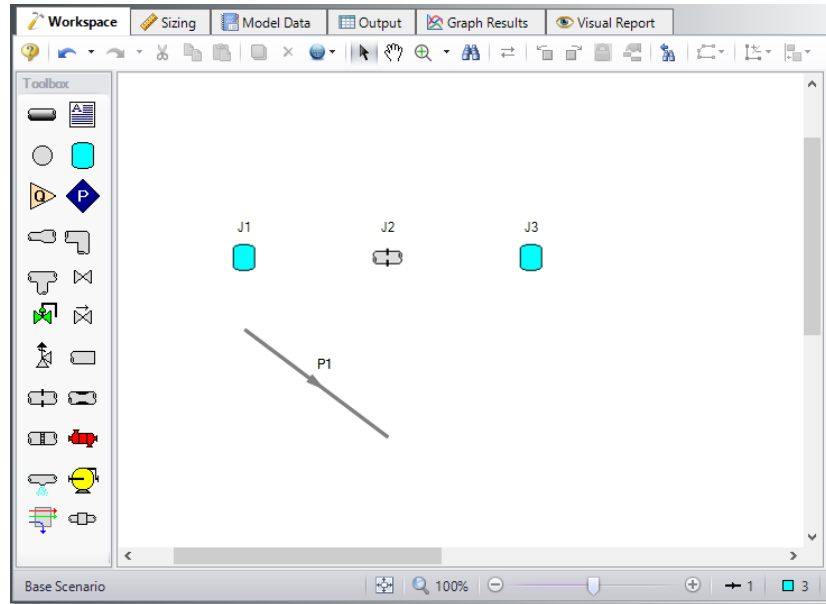

Figure 2.3c Walk through model with the first pipe drawn

- **To place the pipe between J1 and J2**, use the mouse to grab the pipe in the center, drag it so that its left endpoint falls within the J1 Tank icon, then drop it there (see Figure 2.3d). Next, grab the right endpoint of the pipe and stretch the pipe, dragging it until the endpoint terminates within the J2 Orifice icon (see Figure 2.3e).

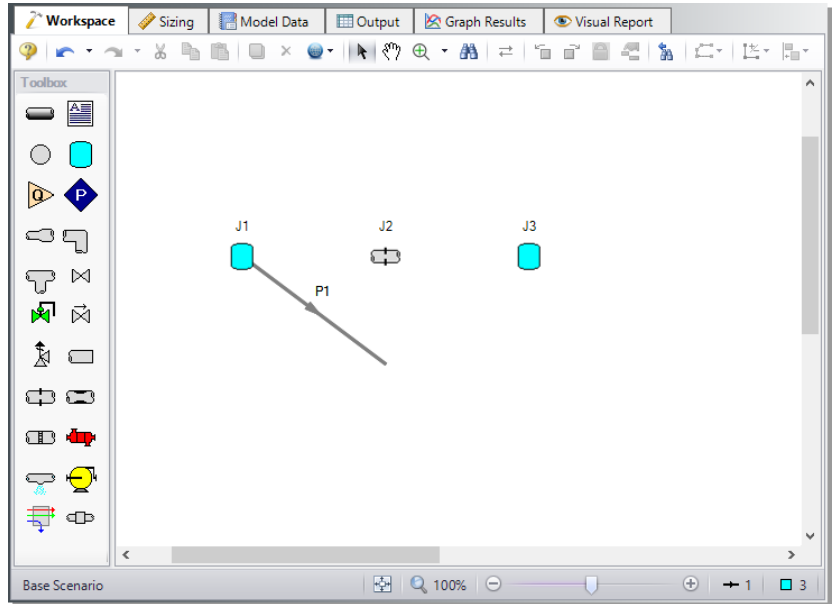

Figure 2.3d Walk through model with the pipe partially connected

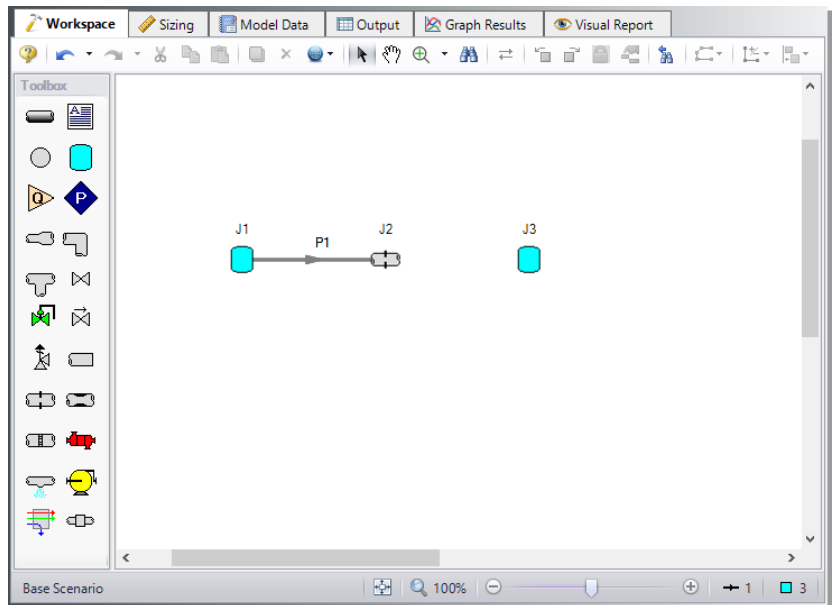

Figure 2.3e Walk through model with the first pipe connected

Reference positive flow direction

The arrow on each pipe indicates the reference positive flow direction for the pipe. The direction does not influence the direction that the flow may go, it influences sign convention only. If the direction of flow calculated by the Solver is the opposite of this reference flow direction, then the output will show the flow rate as a *negative number*.

You can reverse the reference positive flow direction by choosing Reverse Direction from the Arrange menu, selecting the Reverse Pipe Direction button on the Toolbar, or pressing F3.

Although the reference positive flow direction does not need to point in the direction of the actual flow, when used with compressors, the reference direction determines the suction side and discharge side of the compressor.

Note: Examples of other junctions that depend on pipe directions include Control Valves, Check Valves, and Area Changes.

D. Add the remaining pipe

For faster placement, draw the pipe directly between the two junctions.

- **Activate the Pipe Drawing Tool again**, position the mouse pointer on the J2 Orifice, then press and hold the left mouse button. Stretch the pipe across to the J3 Tank, and then release the mouse button. Your model should now look similar to Figure 2.3f.

At this point all the objects in the model are graphically connected. Save the model.

Note: Some users find it desirable to lock objects to the Workspace once placed. This prevents accidental movement and disruption of the connections. You can lock all the objects by first selecting all objects by using CTRL+A or the Edit menu by clicking Select All. Then use CTRL+L or go to the Arrange menu and selecting Lock Object. The lock button on the Workspace Toolbar will appear depressed, indicating it is in an enabled state. Alternatively, you can use the grid feature and snap to grid. The grid options can be modified through the Arrange menu or User Options window.

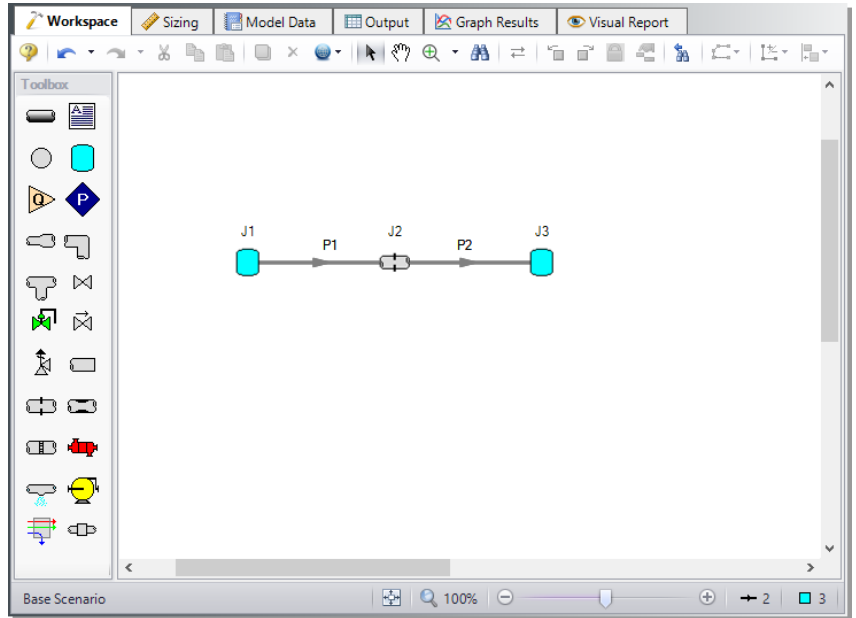

Figure 2.3f Walk through model with all objects placed

Step 3. Specify Analysis Setup

The Analysis Setup window allows the user to define fluid properties, view undefined pipe/junction properties, adjust solution control, enable Add-on Modules if purchased and available on the current license, and specify other simulation settings from a single central location.

- **Click Analysis Setup on the common toolbar.** This opens the Analysis Setup window (see Figure 2.4). The Analysis Setup window contains seven or more *groups* depending on which Add-on Modules you may be using. Each group has one or more *items*. A fully defined group has every item within it defined with all required inputs. Complete every group to run the Solver. A group or item that needs more information will have a red exclamation point to the left of the group or item name. After completing a group, the group icon shows a green circle with a checkmark. After defining all groups, thus completing the Analysis Setup, the Model Status light in the lower-right corner turns from red to green.

A. Modules

Under the Modules group, click on the Modules item to open the Modules panel, shown in Figure 2.4. Here you can enable and disable Add-on Modules if they are available on the license. These Add-on Modules include Goal Seek & Control (GSC), Extended Time Simulation (XTS), and Automated Network Sizing (ANS). By default, the model will have all modules disabled. Make no changes to this panel for this example.

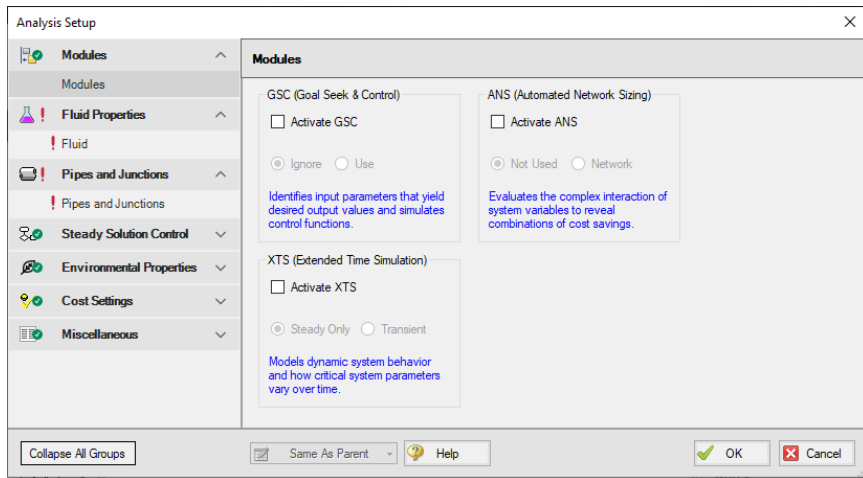

Figure 2.4 On the Modules panel, you can enable or disable any module

B. Fluid Properties

The Fluid Properties group contains the Fluid panel where the fluid used in the model is defined.

You can select a fluid from the standard AFT Arrow fluid library (AFT Standard), select ASME Steam, select multiple fluids and/or create mixtures using the NIST REFPROP library (included in AFT Arrow) or the Chempak library (an optional add-on to AFT Arrow), or create custom fluids. Custom fluids are created by selecting Edit Fluids from the Library menu or by clicking the Edit Fluid List button in the Fluid panel, and can be selected from the User Library.

- Click on the **Fluid** item to open the Fluid panel (see Figure 2.5). For this example, use the AFT Standard fluid library and select “Steam” in the upper list, then click the “Add to Model” button below the list. Leave the Equation of State model as “Redlich-Kwong” and the enthalpy model as “Generalized”.

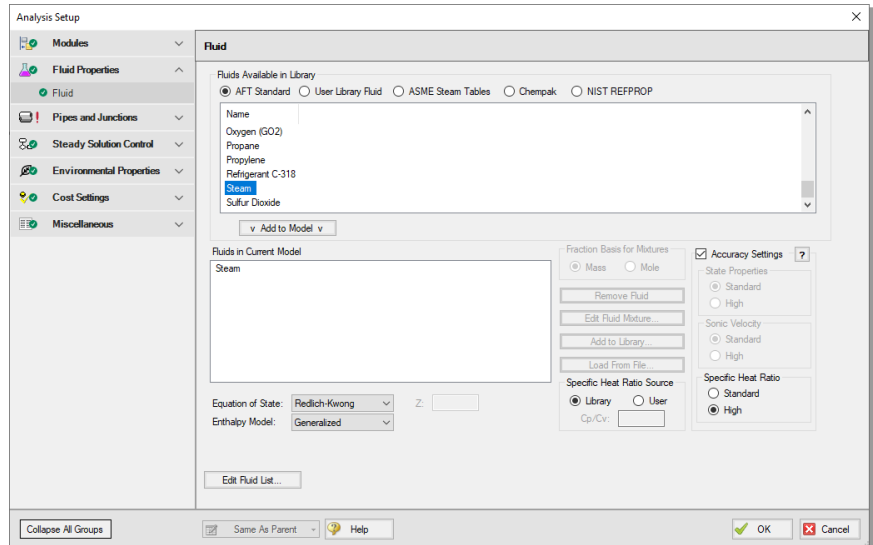

Figure 2.5 Specify the fluid for the analysis in the Fluid panel

C. Pipes and Junctions

The Pipes and Junctions group is less straightforward to define compared to the previous two. This group requires full definition for all pipe and junction properties. Click on the Pipes and Junctions item to open the panel shown in Figure 2.6. Here, you will see all the undefined pipes and junctions. By selecting a pipe or junction in the top or middle section, the remaining properties that need definition appears in the bottom section. Select Pipe 1 for example. Pipe Length, Pipe Inner Diameter, and Roughness/Friction needs input. To define these parameters, you can double click on Pipe 1 from the top section, or go to the Workspace and open the properties window from there. However, before closing the Analysis Setup window, take a look at the final four groups.

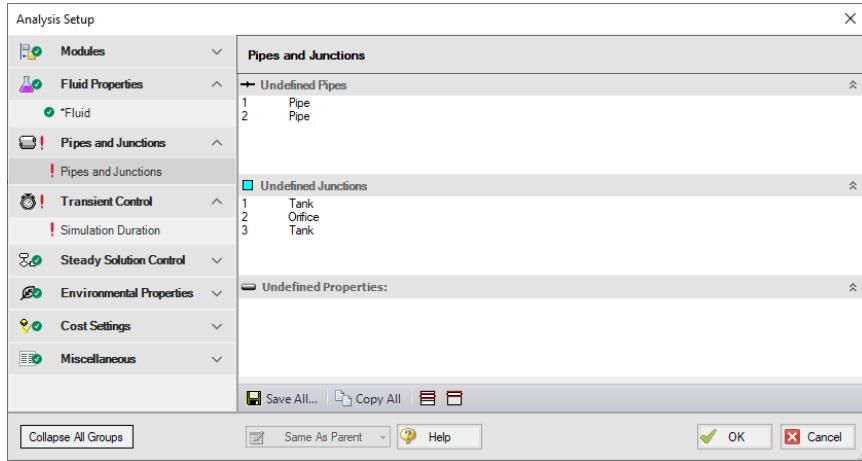

Figure 2.6 The Pipes and Junctions panel lists the remaining undefined objects before the model can run

D. View the final four groups

The remaining groups are Steady Solution Control, Environmental Properties, Cost Settings, and Miscellaneous. In the Steady Solution Control group, you can adjust the tolerance and iteration settings for the Solver; however, the default settings will suffice for the vast majority of use cases, and caution should be taken if editing these settings. On the Environmental Properties panel, you can adjust the ambient pressure, gravitational acceleration, and transition Reynolds Numbers. The Cost Settings panel allows you to select which costs to include as well as define energy costs. The Miscellaneous group has items to specify heat transfer sectioning, as well as change other advanced parameters. The default selections for all of these groups will suffice to fully define these panels.

- **Click OK to accept the changes in Analysis Setup** and to return to the Workspace. The remaining undefined Pipes and Junctions group requires input before the model can run. Complete this item by opening the properties window of the objects directly from the Workspace.

Step 4. Define the model components

Check an object's status to see if a pipe or junction has all the required input.

Object status

Every pipe and junction has an object status. The object status tells you whether the object is defined according to AFT Arrow's requirements. To see the status of the objects in your model, click the light bulb icon on the Workspace Toolbar (alternatively, you could choose "Show Object Status" from the View menu). Each time you click the light bulb, "Show Object Status" is toggled on or off.

When "Show Object Status" is on, the ID numbers for all undefined pipes and junctions are displayed in red on the Workspace. Objects that are completely defined have their ID numbers displayed in black. These colors are configurable through User Options from the Tools menu.

Because you have not yet defined the pipes and junctions in this sample problem, all the object ID numbers will change to red when you turn on "Show Object Status".

Showing undefined objects

Additionally, you can see which remaining objects need input in the Undefined Objects list, similar to what was shown in the Pipes and Junctions panel of the Analysis Setup.

Open the Undefined Objects list (Figure 2.7) using the List Undefined Objects button on the Workspace Toolbar or from the View menu by clicking on "List Undefined Objects". The icon on the Workspace Toolbar is located at the far right end next to the Show Object Status lightbulb icon. This list shows all objects with incomplete information. Clicking on an undefined pipe or junction will display the missing property data. Click the Close button (black X icon) on the bottom right to stop showing this window.

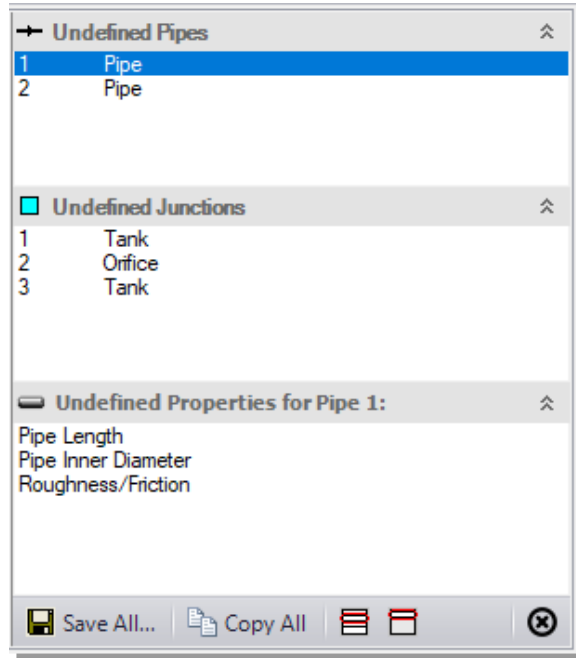

Figure 2.7 The Undefined Objects list lets you see the undefined properties for each undefined object

A. Define the J1 Tank

- **To define the first tank**, open the J1 Tank Properties window (Figure 2.8) by double-clicking on the J1 icon. The pipe table should show you that Pipe P1 is connected to this tank (click the Loss Coefficients tab to display the pipe table).

Note: You can also open an object's Properties window by selecting the object (clicking on it) and then either pressing the Enter key, double-clicking the object, or clicking the Open Pipe/Junction Window icon on the Workspace Toolbar.

Tank Properties

Number:

Name:

Library Jct:

Copy Data From Jct...:

Elevation:

Tank Model | Loss Coefficients | Optional | Design Alerts | Notes | Status

Tank Conditions

Fluid:

Pressure:

Temperature:

Balance Energy in Tank

Figure 2.8 Properties window for the J1 Tank

- **On the Tank Model tab, enter a pressure of 16 barG.** This tank will represent the supply tank upstream of the orifice. Enter a temperature of 260 deg. C and an elevation of 0 meters. You can assign any unit of pressure, temperature, or elevation found in the adjacent dropdown list of units. For this example, keep the units as specified above.

Note: You can choose default units for many parameters (such as meters for length) in the Tools/User Options window under Preferred Units.

You can give the junction a name, if desired, by entering it in the Name field at the top of the window. By default, the junction's name indicates the junction type, and will be displayed in the Model Data and Output. It can optionally be displayed on the Workspace via the use of Workspace Layers which will be discussed later in this chapter. In Figure 2.8, the name of this tank is Inlet Tank.

You can add most junction types into a custom library. This saves the junction inputs for repetitive use within the current model, a completely separate model, or with another user. To select a junction from the custom library, choose the desired junction from the Library Jct list in the junction's property window. The current junction will get the properties from the library.

The Copy Data From Jct list at the top of the properties window shows all the junctions of the same type in the model. This copies the user-selected parameters from an existing junction in the model to the current junction.

Using the tabs in the Properties windows

Separate tabs in the Properties windows contain the junction information and input fields. Click any tab to bring its information forward. Figure 2.8 is an example of a tank's Properties window.

Click the Loss Coefficients tab in the Properties window of J1 to show the pipe table. The pipe table allows you to specify entrance and exit loss factors for each pipe connected to the tank (in this case there is only one). The default selection is for the loss factors to be specified as zero. AFT Arrow defaults to lossless entrance and exits. You can change the loss factors by clicking within the pipe table and entering the loss.

The Optional tab allows you to enter different types of optional data. Depending on the junction type, you can enter initial guesses for the Solver, specify Design Factors, set Special Conditions (like closing a valve or turning off a compressor), and change the junction icon.

Each junction has a tab for notes, allowing you to enter text describing the junction or documenting any assumptions.

The highlight feature displays all the required information in the Properties window in light blue. The highlight is on by default. You can toggle the highlight off and on by double-clicking anywhere in the window above the tabs or by pressing the F2 key. The highlight feature can also be turned on or off by selecting “Highlight in Pipe and Jct Windows” on the View menu.

- **Click OK.** If “Show Object Status” is turned on, you should see the J1 ID number turn black again, telling you that J1 is now completely defined.

The Inspection feature

You can check the input parameters for J1 quickly, in read-only fashion, by using the Inspection feature. Position the mouse pointer on the J1 tank icon and hold down the right mouse button. The inspection window appears, as shown in Figure 2.9.

Inspecting is a faster way of examining the input (and output if results are available) than opening the Properties window.

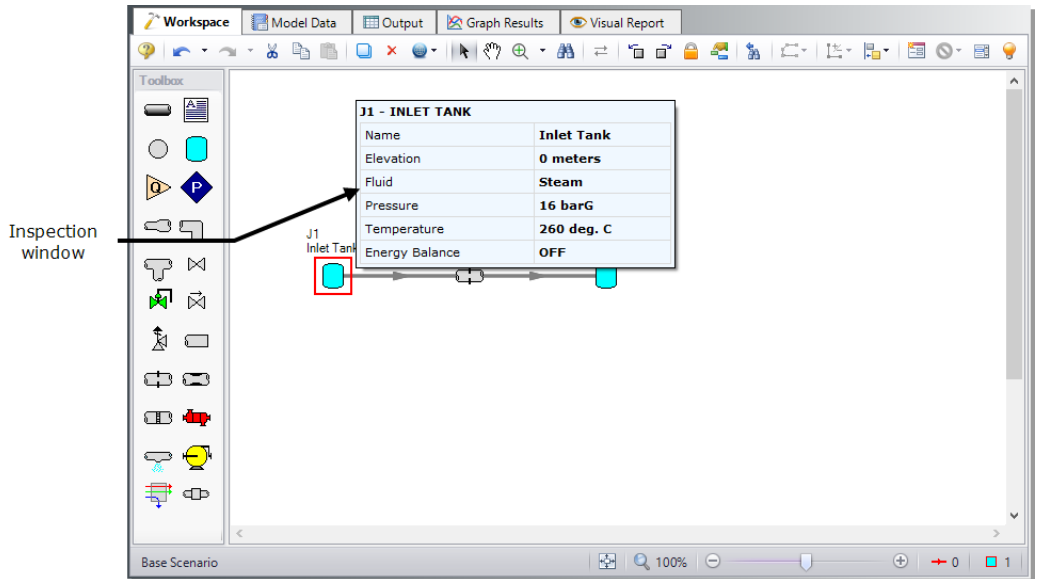

Figure 2.9 Inspecting from the Workspace with the right mouse button

B. Define other junctions

- **Next, open the Properties window for the J2 Orifice junction.** Enter the Orifice Type as User Specified, the Subsonic Loss Model as K Factor, $K = 10$, and the elevation as 0 meters (see Figure 2.10). Click OK to close the window.
- **Open the J3 Tank junction** and change the name to Discharge Tank. Then enter a pressure of 0 barG, a temperature of 260 deg. C and an elevation of 0 meters.
- **Save the model** again before proceeding.

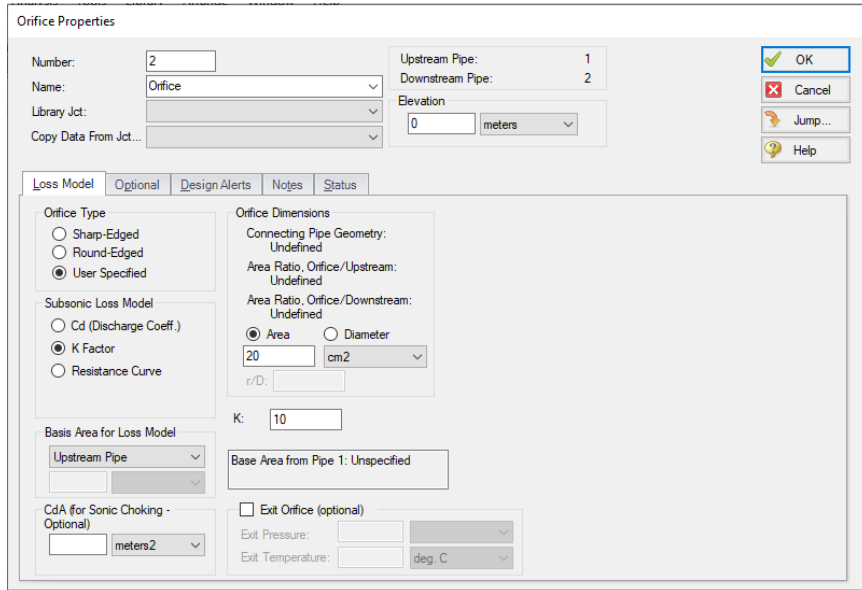

Figure 2.10 Properties window for the J2 Orifice

C. Define Pipe P1

You can enter data for pipes and junctions in any order. In this example, we defined the junctions first. Next, define all the pipes. To open the Pipe Properties window, double-click the pipe on the Workspace.

- **First, open the Pipe Properties window for Pipe P1.** For Pipe P1 choose Steel - ANSI, 2 inch, STD (schedule 40), Standard friction model, and a length of 3 meters (Figure 2.11).

The Pipe Properties window

The Pipe Properties window offers control over all important flow and heat transfer parameters that are related to pipes.

The Inspect feature can be accessed not only from pipes and junctions located on the Workspace, but also from *within* the Properties window of each pipe (and certain junctions). This is helpful when you want to quickly check the properties of objects that connect to a pipe or junction whose Properties window you already have open.

To Inspect a junction connected to a given pipe, position the mouse pointer on the connected junction's ID number in that pipe's Properties window (located at the top right of the Pipe Properties window) and hold down the right mouse button. This process can be repeated for any junction that states the upstream and downstream pipe in the junction's Properties window. You can jump to that junction's Properties window by double-clicking the connected junction's ID number, or use the Jump button to jump to any other part of the model.

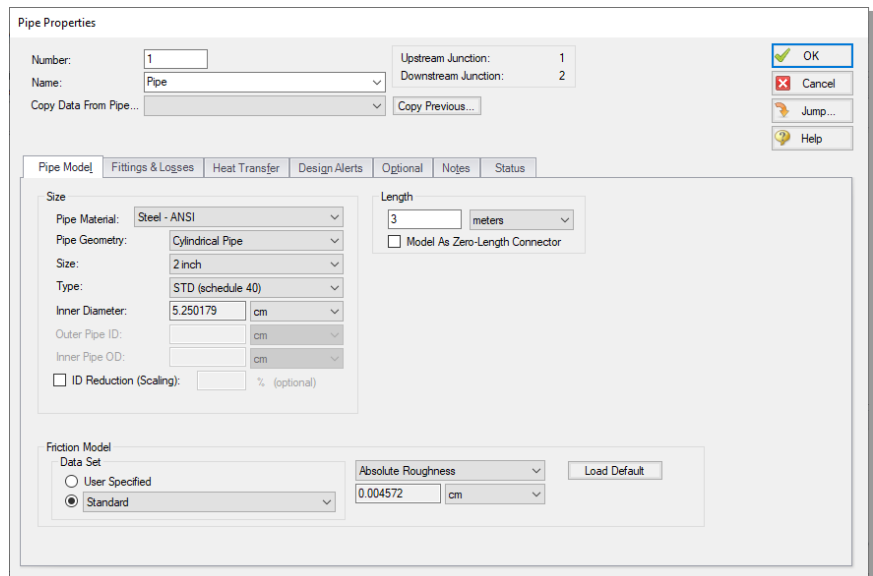

Figure 2.11 Properties window for Pipe P1

D. Define Pipe P2

- **Open the Properties window for Pipe 2** and specify Steel - ANSI, 2 inch, STD (schedule 40), Standard friction model, and a length of 6 meters. You will note that the pipe size and type is remembered from the previous pipe (this can be configured in the User Options window under Pipes and Junctions in the Parameters section). You can also choose the “Copy Data From Pipe” dropdown and select the parameters from any other pipe to apply to this pipe. Click OK to save your changes.

E. Check pipes and junctions

- **Check if all the pipes and junctions are defined.** If all the panels in the Analysis Setup have their required inputs, the Status Light on the Quick Access Panel will be green. If not, view the Undefined Objects list from the Analysis Setup, or turn on Show Object Status from the View menu, and open each undefined pipe and junction. The Status tab on each Properties window will indicate the missing information.

F. Review Model Data

- **Before running the model,** save it to file one more time. It is also a good idea to review the input using the Model Data window.

Reviewing input in the Model Data window

The Model Data window is shown in Figure 2.12. To change to this window, you can click on the Model Data tab, select it from the Window menu, or press CTRL+M. The Model Data window gives you a text-based perspective of your model. Selections can be copied to the clipboard and transferred into other Windows programs, saved to a formatted file, printed to a PDF, or printed out for review.

Data displays in three sections: the General Data section at the top, the Pipe Data section in the middle, and the Junction Data section at the bottom. Each section collapses using the buttons at the top-left of the section. Further, each section can be resized.

The Model Data window allows access to all Properties windows by double-clicking on any input parameter cell in the row of the pipe or junction you want to access.

General data section

Pipe data section

Junction data section

Pipe	Name	Pipe Defined	Zero-Length Connector	Length	Length Units	Hydraulic Diameter	Hydraulic Diam. Units	Friction Data Set	Roughness	Roughness Units	Losses (K)	Initial Flow	Initial Flk Units
1	Pipe	Yes	No	3 meters		5.250179 cm		Standard	0.004572 cm		0		
2	Pipe	Yes	No	6 meters		5.250179 cm		Standard	0.004572 cm		0		

Orifice	Name	Object Defined	Elevation	Elevation Units	Initial Pressure	Initial Pressure Units	Library Source	Orifice Type	Flow Area Type	Dimension	Dimension Units
2	Orifice	Yes	0 meters					Custom	Area	20 cm ²	

Figure 2.12 The Model Data window shows all input in table form

Step 5. Run the model

- Choose “Run Model” from the Run Model icon on the Main Toolbar or the Analysis menu. During execution, the Solution Progress window is displayed and can be used to pause or cancel the Solver's activity (see Figure 2.13). When the solution is complete, click the Output button and the text-based Output window will appear (see Figure 2.14). The information in the Output window can be reviewed visually, saved to file, exported to a spreadsheet-ready format, copied to the clipboard, printed to PDF, or printed out on the printer.

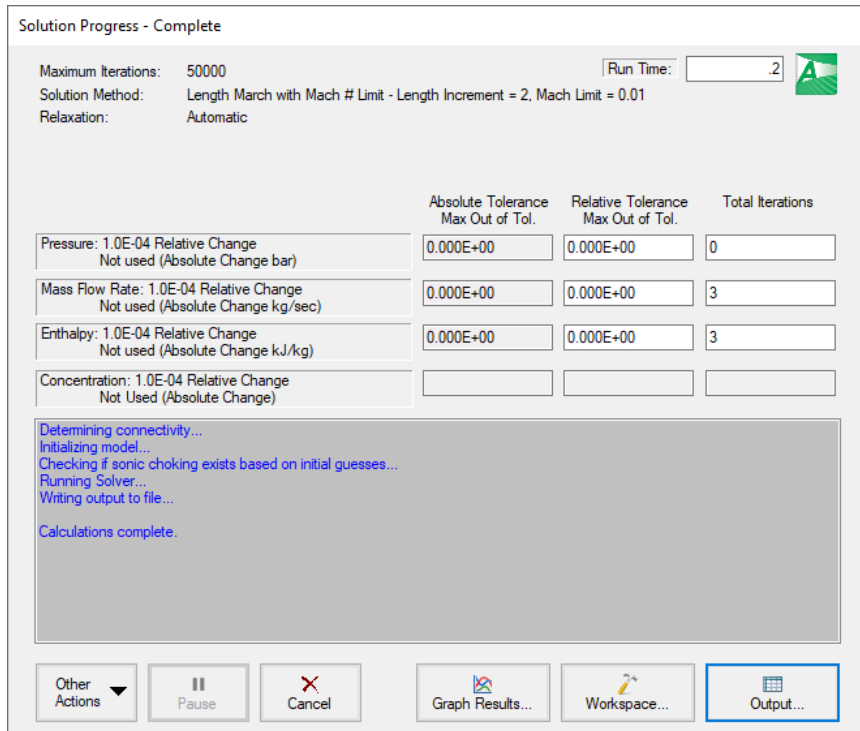

Figure 2.13 The Solution Progress window displays the Solver's convergence progress

The output file

When the Solver runs, the output data is written to a file. This file is given the same name as the model itself with a number appended to the name, and with an *.out extension appended to the end. For all data processing, graphing, etc., the data is extracted from this file. The number is appended because users are able to build different scenarios all within this model. Each scenario will have its own output file; thus, the files need to be distinguishable from each other.

The output file will only remain on disk if you save the model after it has been run. Once saved, it will remain until the user erases it or the model input data is modified.

- **Save the model file again** such that the output file is saved to the disk. This means that if you were to close your model right now and then

reopen it, you could proceed directly to the Output window for data review without rerunning your model.

Step 6. Review the output

The Output window (Figure 2.14) is similar in structure to the Model Data window. Three areas are shown, and you can expand or collapse each area by dragging the boundary between the areas up or down, or by clicking the arrow beside the area label. The items displayed in the tables are those items you choose in the Output Control window.

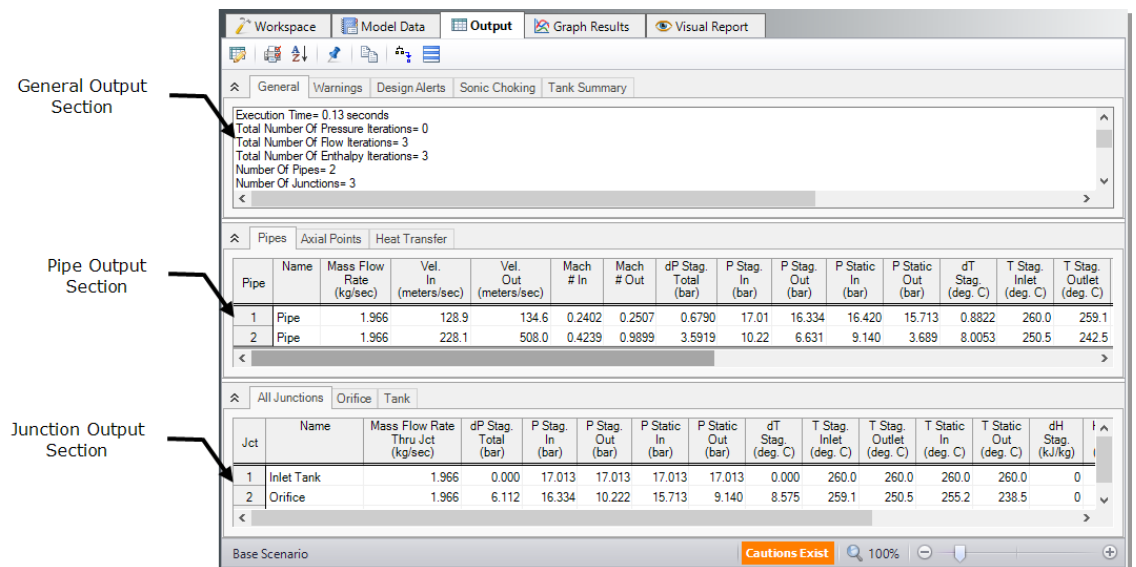

Figure 2.14 The Output window displays output in tabular form

This system chokes at the discharge tank. When a system chokes, Arrow will display the “Sonic Choking” tab in the General Output section (see Figure 2.15). This tab will appear when sonic choking occurs in the system, and will contain messages pertaining to the sonic choking locations.

Because the flow is choked at the exit, the mass flow rate shown in the output reflects the maximum flow rate through the system for the given inlet conditions. The choked flow rate through this system is 1.97 kg/sec and the pressure at the exit is 6.63 bar (i.e., stagnation pressure at

34 AFT Arrow™ 10 Quick Start Guide

Pipe P2 outlet). The output in the junction data portion of the Output window shows the Sonic Area at the orifice is 8.89 cm², and the Sonic Area at the discharge tank is 21.65 cm². The sonic area at the discharge tank is equal to the pipe physical area of the 2 inch, standard schedule pipe since the system chokes at the discharge tank, and the connecting pipe, P2, has no restriction at the end.

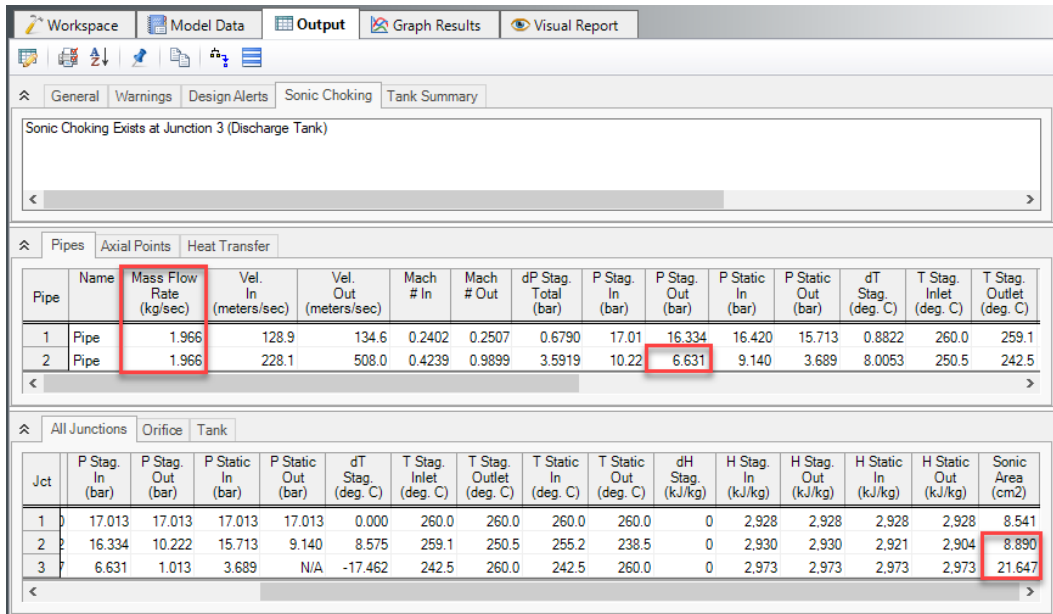

Sonic Choking Exists at Junction 3 (Discharge Tank)

Pipe	Name	Mass Flow Rate (kg/sec)	Vel. In (meters/sec)	Vel. Out (meters/sec)	Mach # In	Mach # Out	dP Stag. Total (bar)	P Stag. In (bar)	P Stag. Out (bar)	P Static In (bar)	P Static Out (bar)	dT Stag. (deg. C)	T Stag. Inlet (deg. C)	T Stag. Outlet (deg. C)
1	Pipe	1.966	128.9	134.6	0.2402	0.2507	0.6790	17.01	16.334	16.420	15.713	0.8822	260.0	259.1
2	Pipe	1.966	228.1	508.0	0.4239	0.9899	3.5919	10.22	6.631	9.140	3.689	8.0053	250.5	242.5

Jct	P Stag. In (bar)	P Stag. Out (bar)	P Static In (bar)	P Static Out (bar)	dT Stag. (deg. C)	T Stag. Inlet (deg. C)	T Stag. Outlet (deg. C)	T Static In (deg. C)	T Static Out (deg. C)	dH Stag. (kJ/kg)	H Stag. In (kJ/kg)	H Stag. Out (kJ/kg)	H Static In (kJ/kg)	H Static Out (kJ/kg)	Sonic Area (cm ²)
1	17.013	17.013	17.013	17.013	0.000	260.0	260.0	260.0	260.0	0	2.928	2.928	2.928	2.928	8.541
2	16.334	10.222	15.713	9.140	8.575	259.1	250.5	255.2	238.5	0	2.930	2.930	2.921	2.904	8.890
3	6.631	1.013	3.689	N/A	-17.462	242.5	260.0	242.5	260.0	0	2.973	2.973	2.973	2.973	21.647

Figure 2.15 The Output window displays the Sonic Choking tab whenever sonic choking occurs in the system

Step 7. Customize the output

The Output Control window (Figure 2.16) allows you to select the specific output parameters you want in your output. You can also choose the units for the output. If you do not change any of the Output Control settings, default Output Control parameters and a default title are assigned.

- **Select Output Control** from the Tools menu or the Main Toolbar to open the Output Control window (Figure 2.16). On the Display Parameters tab, select the Pipes button. The list of selected pipe output

parameters will be displayed on the right hand side. By default, the pipe results in the Pipes table will show mass flow rate in the second column with units of kg/sec. Change the units for Mass Flow Rate by selecting kg/hr (kilograms per hour) from the unit list shown beside the parameter.

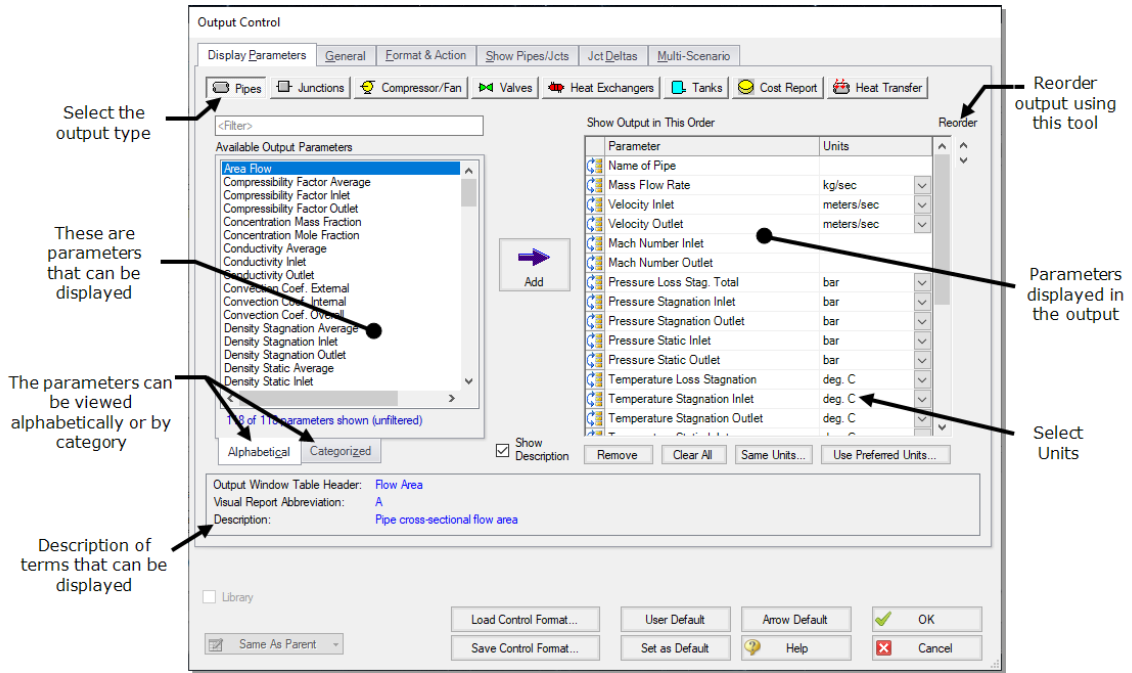

Figure 2.16 The Output Control window lets you customize the output

- **Click OK to display changes** to the current results. You should see the mass flow rate results, still in the second column, in units of kg/hr.
- **Select Output Control from the Tools menu** one more time. Select the Display Parameters tab, and select the Pipes button. The Reorder scroll bar on the far right allows you to reorder the sequence of parameters that will be displayed in the output. You can also click on the reorder symbol on the left side of each row to manually drag-and-drop the rows to change the parameter order (see Figure 2.16).

- **Select the Velocity Inlet parameter** and use the Reorder scroll bar or drag-and-drop to move it up to the top of the parameter list.
- **Click OK to display the changes** to the current results. Now, you will see in the Pipes table that the first column now contains “Vel. In”, the second column now contains the pipe name, and the third column contains the mass flow rate. The Output Control window allows you to specify the parameters, units, and display order of the parameters that you want to see in the output. This flexibility will help you work with AFT Arrow in the way that is most meaningful to you, reducing the possibility of errors.
- **Lastly, double-click the column header** for the “Vel. In” parameter in the Output window in the Pipes table. This will open a window in which you can change the units once again if you prefer (see Figure 2.17). These changes are extended to the Output Control parameter data you have previously set.

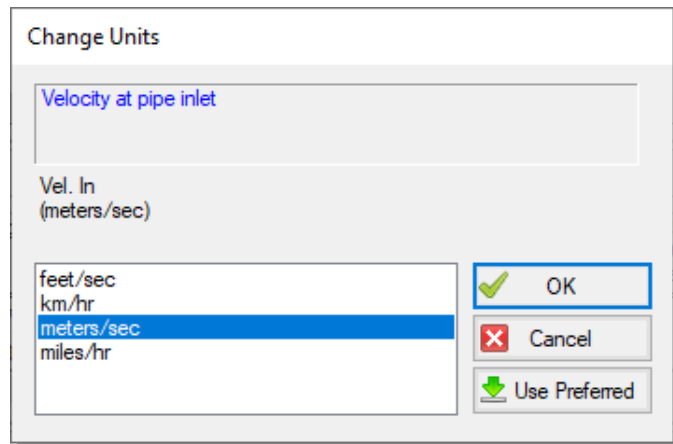

Figure 2.17 The Change Units window is opened from the Output window tables by double-clicking the column header

Step 8. View the Workspace Layers

Workspace Layers can display input and output values superimposed over the model, and color pipes automatically based on output values.

- **Navigate to the Workspace window** by clicking on the Workspace tab or pressing CTRL+W. Select the Workspace Layers tab in the bottom-right of the Quick Access Panel. The Workspace Layers panel contains two sections named Layer Presets and Layers.

Within the Layers section, there are two expandable or collapsible groups which contain the two *layer types* named Color Maps and Standard layers. We will integrate the model results with the graphical layout of the pipe network by using the All Objects Layer located under the Standard group. The All Objects Layer is the bottommost layer for all models and shows all pipes, junctions, and annotations when the layer is visible. Layer visibility can be toggled on/off using the eye icon next to the layer. The combination of layers and toggling visibility allows for a wide range of visual customization, and the All Objects Layer will always provide a safety net to keep track of all objects in the model.

- **Open the Layer Settings window for the All Objects Layer** by double-clicking the All Objects Layer, clicking the gear icon to the left of the layer name, or selecting the layer and clicking the single gear icon on the Layers Toolbar (Figure 2.18).

The Layer Settings window provides flexible options for customizing the appearance of the model. The Pipes & Junctions group allows you to show or hide junctions, and change display properties like color, size, and thickness. Note that you cannot hide individual objects on the All Objects Layer, but you can hide objects on new layers, and then hide the entire All Objects Layer below. The Label Control group allows you to display input and output parameters next to objects on the Workspace. The Annotations group allows you to customize annotations.

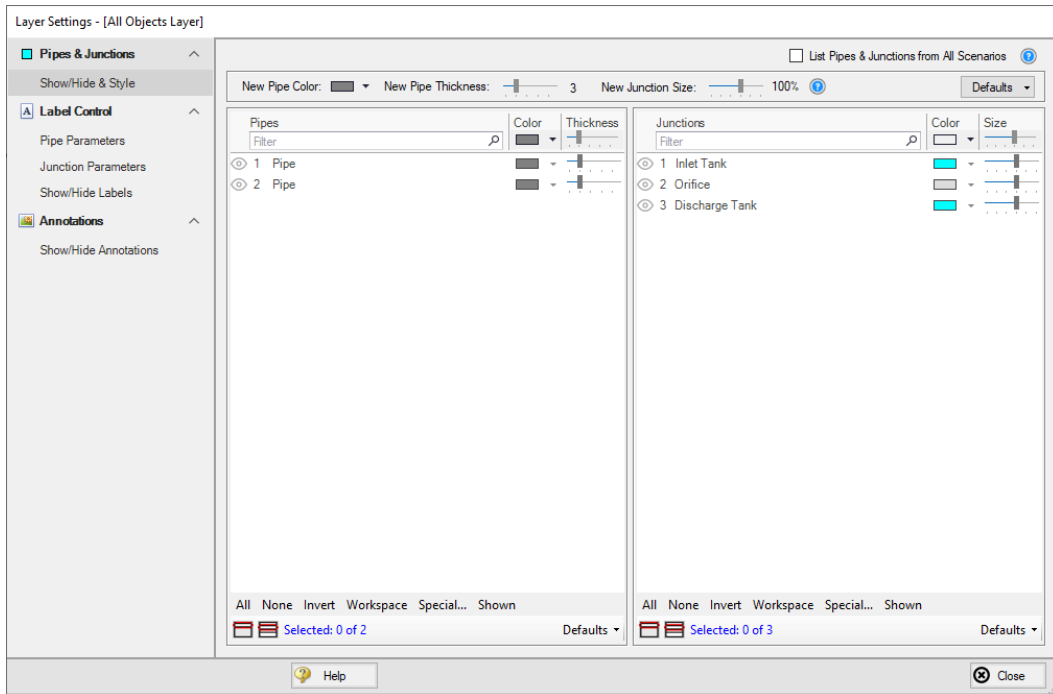

Figure 2.18 The Layer Settings window specifies content to be superimposed on the Workspace

- **Select the Pipe Parameters item under the Label Control group.** The left pane lists input and output parameters available for display, and the right pane lists the parameters currently being displayed by the layer on the Workspace.
- **In the left pane, expand the Pipe Parameters list.** Then, select the Velocity Inlet parameter with units of meters/sec. Add it to the right pane by either double-clicking the parameter, or selecting the parameter and clicking the arrow between the panes.
- **Select the Junction Parameters item under the Label Control Group.** Expand the Junction Parameters list and add the Pressure Static Inlet parameter with units of bar. Expand the Commonly Used Junction Parameters list and add the Junction Name parameter. Select the Junction Name parameter and reorder it above the pressure parameter using the up arrow in the top-right. Close the Layer Settings using the

button in the bottom-right.

- **Add additional clarity by repositioning the labels and adding a legend.** It is common for the text on the Workspace Layers to overlap with objects when first generated. Labels can be dragged to a new area or a smaller font can be selected using the Font Decrease icon on the Workspace Toolbar. Parameter units can be consolidated in a legend which can be added via the Global Layer Settings. In the Layers Toolbar, click the double gear icon to open the Global Layer Settings. Then, enable the checkbox for Show Units in Legend. The result of these adjustments is shown in Figure 2.19.

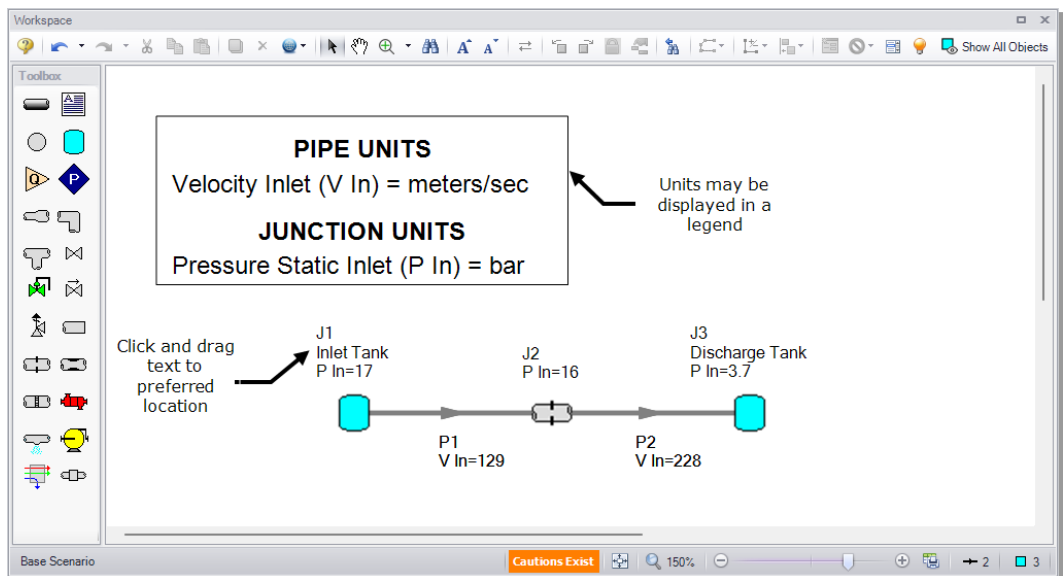

Figure 2.19 Results are superimposed on the model layout via Workspace Layers

Step 9. View the Graph Results

- **Change to the Graph Results window** by clicking on the Graph Results tab or choosing it from the Window menu. The Graph Results window offers versatile graph generation and preparation.

AFT Arrow's Graph Guide, accessed by clicking on the "What Would You Like to Do?" button located at the top-right of the Graph area,

provides assistance by guiding you through the creation of a “Quick and Simple” graph, or an “Advanced” graph (Figure 2.20). You can create a graph by following the prompts on the Graph Guide, by manually specifying the graphing parameters on the Graph Control tab on the Quick Access Panel, or from the “Select Graph Parameters” icon located in the top-left corner of the Graph Results toolbar. For the remainder of this Quick Start Guide, the Graph Guide will be hidden, but keep in mind that you can use it whenever you would like assistance in creating a graph.

Figure 2.21 shows the Graph Results window with the Graph Control tab enabled on the Quick Access Panel.

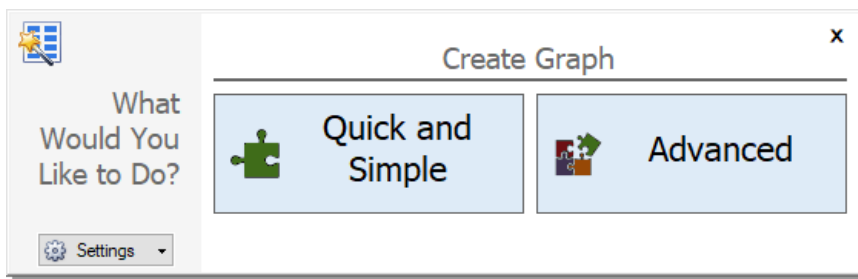

Figure 2.20 The Graph Guide can be toggled on and off by clicking the “What Would You Like to Do?” button on the Graph Results window

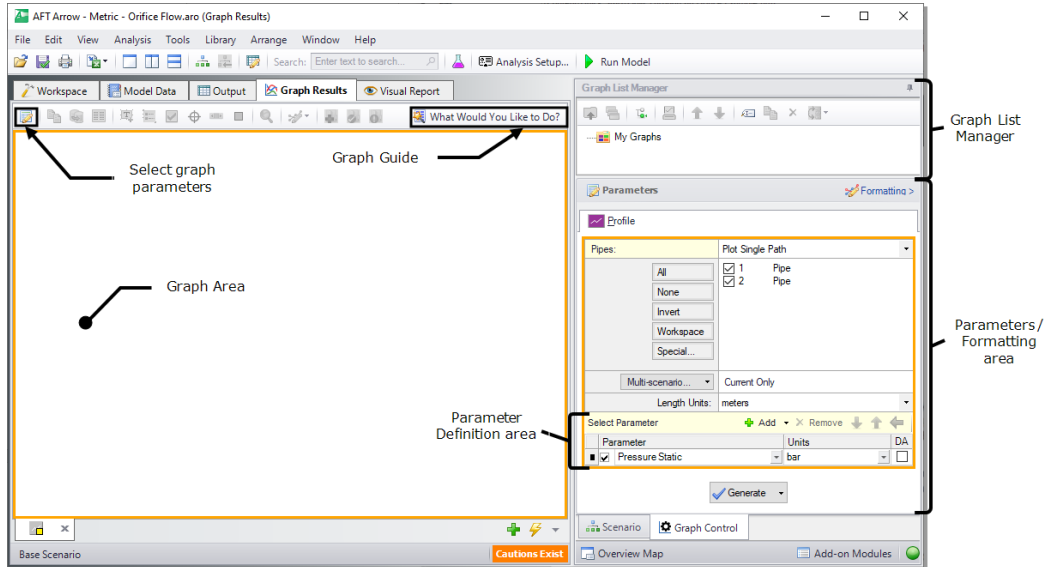

Figure 2.21 The Graph Results window is where various system parameters can be graphed

AFT Arrow gives you the ability to create *stacked graphs*. These are graphs that are displayed on top of each other with the same x-axis but with different parameters on the y-axis. This feature helps show the output of multiple parameters in the same location of your model simultaneously without creating completely separate graphs.

- **Click the Profile tab on the Parameters pane.** In the Pipes selection list, click the All button to select all the pipes.
- **For the Length Units,** keep the default units of meters.
- **From the Parameters definition area,** keep Pressure Static selected and select units of barG.
- **To add a stacked graph,** click the Add button with the green “+” icon next to Select Parameter, shown in Figure 2.22. A new row under the Parameters definition area will appear.
- **Choose Velocity in this new parameter row,** and select units of meters/sec.

- Click the **Generate** button to create the stacked pressure and velocity graphs, shown in Figure 2.23. Note that the total static pressure loss across the orifice is approximately 6.6 bar.
- To **format the legend font size**, right-click on a legend and use the slider bar to decrease the font size to 12 for both graphs. Drag the static pressure graph legend to the upper-right corner of the graph to improve visibility of the graphed data.
- To **format each axis font size**, right-click on each axis title and use the slider bar to decrease the size until the font size on each axis appears as you like.

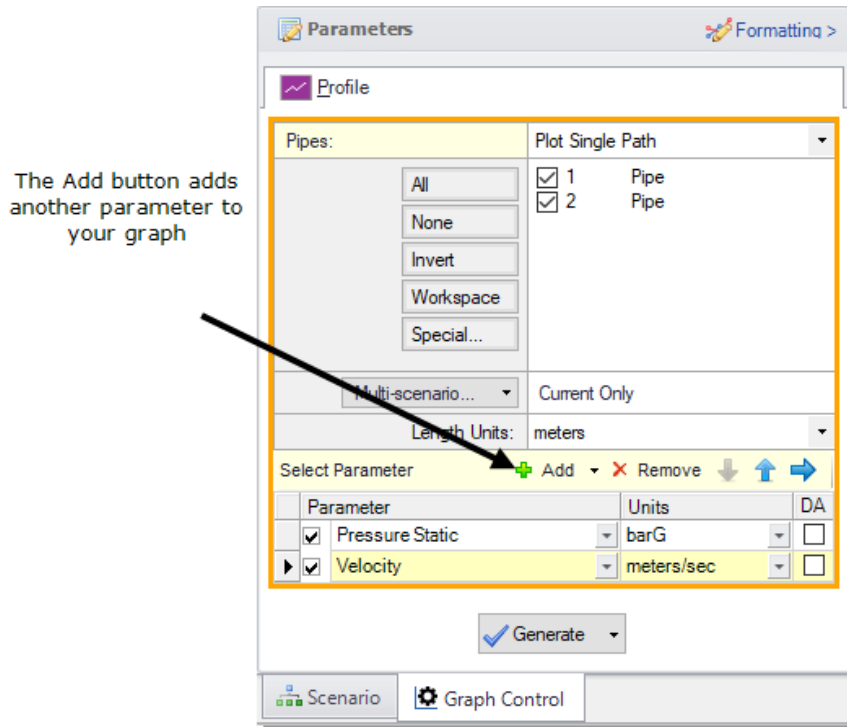

Figure 2.22 The Graph Control tab on the Quick Access Panel allows you to specify the graph parameters you want to graph in the Parameters/Formatting area

The Formatting area on the Graph Control tab can be used to modify the graph colors, fonts, and other elements. Options to copy the graph image

or x-y data are available on the Graph Results Toolbar or by right-clicking the graph. The graph image or x-y data can be saved from the File menu.

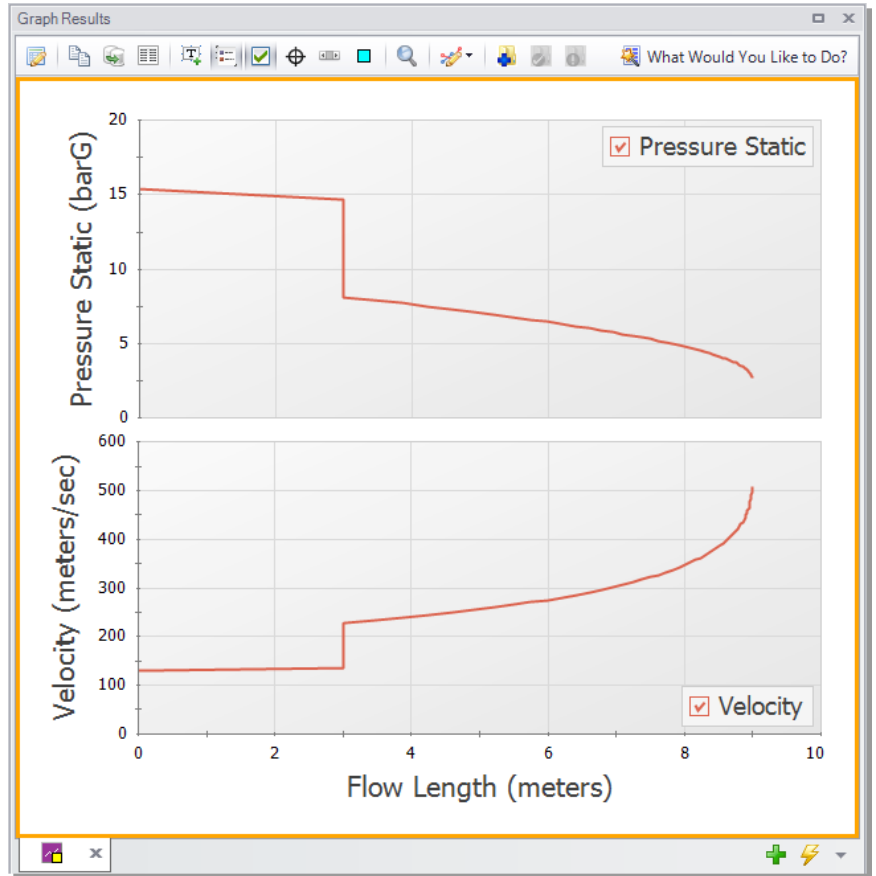

Figure 2.23 The Graph Results window showing a graph of the static pressure and velocity along the entire length of the pipeline

Step 10. Modify the system

So far in this example, there has been no input for “CdA for Sonic Choking” on the Orifice Properties window. This input is optional, but without a CdA input, sonic choking cannot be checked at this location,

and choking would not occur at the orifice. Sonic choking can occur at a different location, as was seen at the J3 Tank junction.

To see the effects of CdA, enter a CdA that is 20% higher than the sonic area, and run the Arrow model again. The previous sonic area at J2 was 8.89 cm^2 , and the new value should be 10.668 cm^2 (i.e., 20% higher). How do the results change? What happens if you set the optional orifice CdA to a value 20% lower than the sonic area (7.112 cm^2)?

Note: This is a situation where a user could create two new scenarios using the Scenario Manager to examine several "what-if" situations, without disturbing the basic model. See Chapter 3 for an example that illustrates how to use the Scenario Manager.

When the orifice CdA is set to a value higher than the sonic area, it has no effect on the model. However, setting the orifice CdA to a value lower than the sonic area will result in sonic choking at that location.

Here, a value 20% lower than the sonic area causes the flow rate to decrease from 1.97 to 1.59 kg/sec, and the discharge pressure to decrease to 5.37 bar. For this system, lowering the orifice CdA to a value 20% less than the sonic area also causes the system to choke in two places rather than just one. This can be seen on the Sonic Choking tab in the General Output window.

Conclusion

You have now used AFT Arrow's Primary Windows to build and analyze a simple model.

Compressed Air System Analysis Example

This example demonstrates how to determine the range of outlet temperatures for a compressed air system, given a range of numerous design assumptions.

Topics covered

- Entering heat transfer data for piping
- Modeling compressors with curve data
- Modeling heat of compression at compressors
- Modeling junction losses with a resistance curve
- Using scenarios
- Using the Global Pipe Edit feature
- Using the Isometric Pipe Drawing Mode

Required knowledge

This example assumes that the user has some familiarity with AFT Arrow such as placing junctions, connecting pipes, and entering pipe and junction properties. Refer to the example in Chapter 2 for more information on these topics.

Model file

A completed version of the model file can be referenced from the Examples folder as part of the AFT Arrow installation:

C:\AFT Products\AFT Arrow 10\Examples

- *Metric - Compressed Air System.aro*

Problem statement

In this example, four machine tools are supplied air for operations. The machine tools are sensitive to temperature, but the manufacturer says they can compensate for this if they know the extremes of the delivery temperature the tools will see.

The air is taken from outside the building ($P = 0$ barG), and the air temperature outside can vary from -18 to 45 deg. C. The temperature inside the building ranges from 21 to 24 deg. C. The ambient air velocity ranges from 1.5 to 25 km/hr.

The compressor used to drive the system has the following stagnation pressure rise characteristics: 83 kPa at 0 kg/sec, 69 kPa at 0.25 kg/sec, and 41 kPa at 0.5 kg/sec. The compressor efficiency is not known with certainty, but it is expected to be between 80% and 90%.

The nozzles at the tools have a pressure drop of 55 kPa at 0.1 kg/sec. The nozzles discharge to atmospheric pressure.

The pipes in the system are uninsulated steel. The pipe at the compressor inlet is heavily insulated (adiabatic). All of the components in the system are at an elevation of 0 meters.

Determine the temperature extremes of this system, so the machine tools manufacturer can compensate for the tool's temperature sensitivity.

Step 1. Specify fluid properties

1. Open Analysis Setup from the Common Toolbar or the Analysis menu.

2. Under the Fluid Properties group, click the Fluid item to open the Fluid panel. Select the AFT Standard library and then select “Air” in the “Fluids Available in Library” list.
3. Click “Add to Model” to select air for use in this model.
4. Use the default “Redlich-Kwong” for the equation of state and “Generalized” for the enthalpy model.
5. Click OK to accept the changes and close Analysis Setup.

Step 2. Build the model

A. Place the pipes and junctions

This completes the first two groups of the Analysis Setup. The Pipes and Junctions group remains undefined. To complete this group, begin by assembling the model on the Workspace as shown in Figure 3.1.

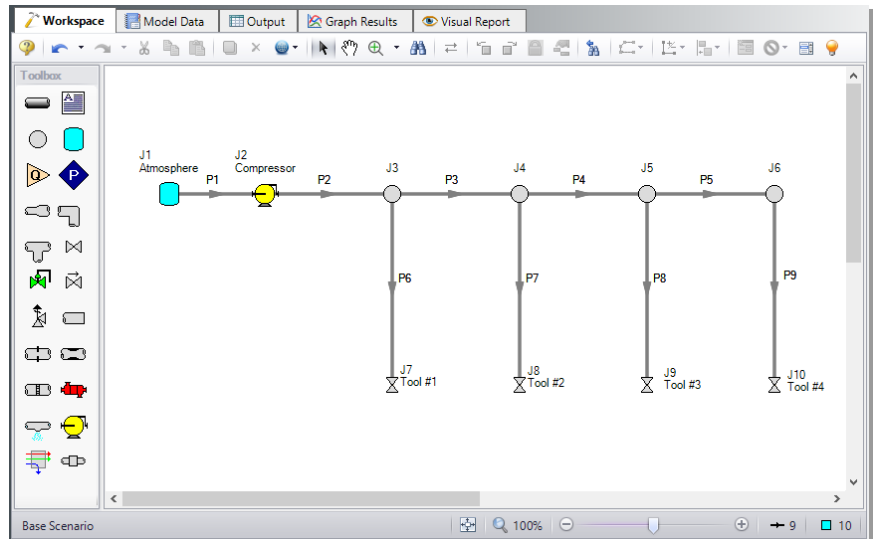

Figure 3.1 Layout of the pipe system for the Compressed Air System Example

B. Enter the pipe data

With the objects in place, define the input data for the pipes and junctions. Double-click each pipe object, and enter the following data in the Properties window:

All of the pipes are Steel - ANSI, with standard roughness, and the following data:

Pipe	Length (meters)	Nominal Size	Type
P1	0.3	2 inch	Schedule 40
P2 - P5	8	2 inch	Schedule 40
P6 - P9	3	1 inch	Schedule 40

1. Because the pipe at the compressor inlet (P1) is very well insulated for all of the cases you will analyze, it can be considered adiabatic. Open the Properties window for Pipe P1 and select the Heat Transfer tab. Ensure that the Heat Transfer Model is set to “Adiabatic (Perfectly Insulated)”, then click OK.
2. For the remaining uninsulated pipes (P2-P9), you will need to set the pipe heat transfer properties on the Heat Transfer tab on the Pipe Properties window.

AFT Arrow has a feature that can be used to change the heat transfer properties for multiple pipes at the same time. This feature is called Global Pipe Edit.

Open the Global Pipe Edit window from the Workspace Toolbar or the Edit menu. Click “All” to select all of the pipes shown in the Pipe List. Then click on the check box beside Pipe 1 to deselect it. Since Pipe 1 has different properties than the other pipes (it is adiabatic), you should not include it in this global change. The Global Pipe Edit window should appear as shown in Figure 3.2.

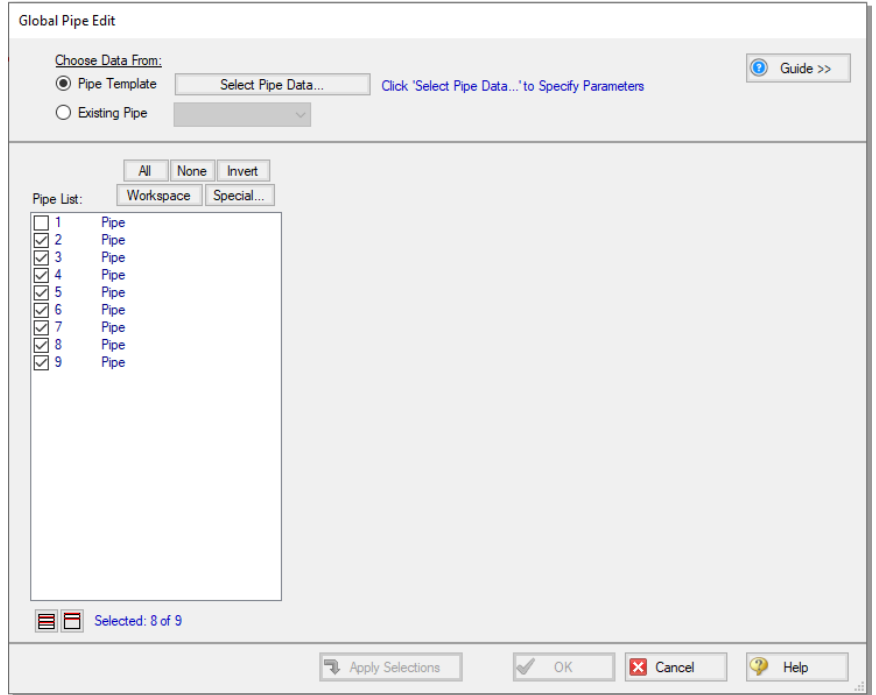

Figure 3.2 Global Pipe Edit window showing the pipes selected to be included in the global edit

Click the Select Pipe Data button. This will open a template Pipe Properties window that will be used to enter the pipe parameters we wish to change on all of the selected pipes.

On the Pipe Model tab, set the Pipe Material to Steel - ANSI. No other changes are necessary on this tab.

Click on the Heat Transfer tab. Select “Convective Heat Transfer” for the Heat Transfer Model, and enter 24 deg. C for the Ambient Temperature and 1.5 km/hr for the Fluid Velocity with Air as the fluid. Also, ensure that the Gnielinski correlation is selected under the Convection Coefficient column in the Fluid Internal row, and that Forced (Churchill-Bernstein) is chosen in the External row. The Pipe Properties window should appear as shown in Figure 3.3. Select OK.

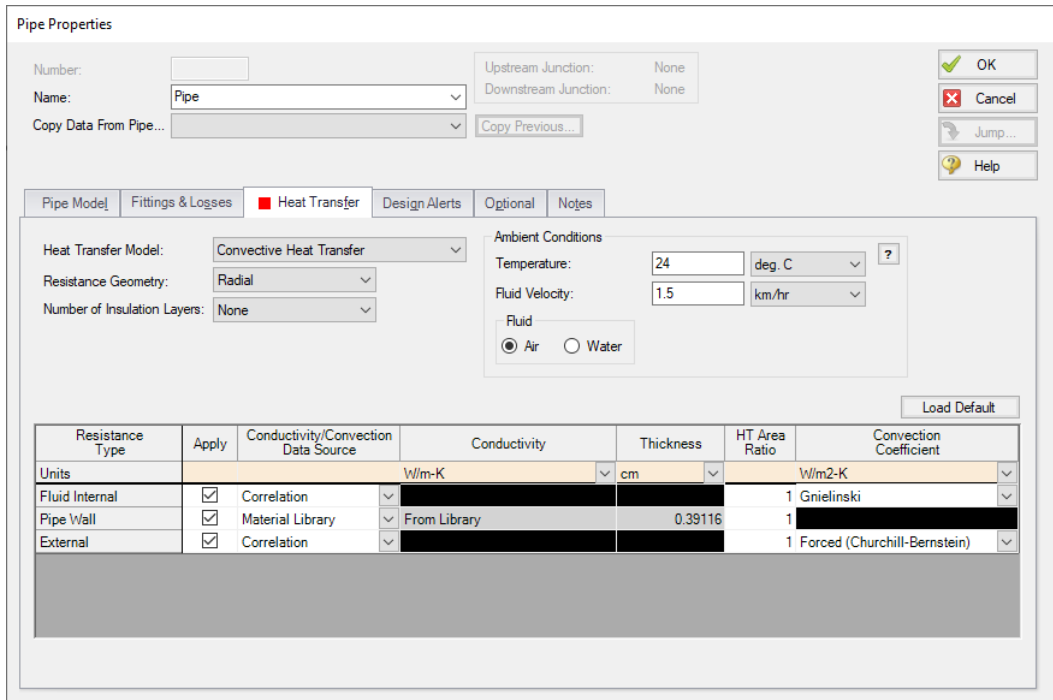

Figure 3.3 The Heat Transfer tab is where you specify heat transfer properties for the pipe

The Global Pipe Edit window will now display a list of all the parameters that may be applied to the selected pipes. The parameters are categorized as they are displayed on the tabs of the Pipe Properties window. For this example, you want to select all of the parameters listed in the Heat Transfer category (see Figure 3.4). Since these items are the only things selected in the parameter list, they are the only parameters that will be changed in the pipes.

Apply the changes to the selected pipes by clicking the Apply Selections button. AFT Arrow will notify you that the changes were successfully applied with a message in the bottom-left of the Global Pipe Edit window. If you wish to cancel all of the changes you applied, click Cancel on the Global Pipe Edit window. Otherwise, accept the changes by clicking OK.

Note: The Guide button in the Global Edit windows may be used as a reminder of the required steps for the global edit process if needed.

The heat transfer data for Pipes P2-P9 have all been updated to reflect the new values. Open the Properties window for one of the pipes to verify that the changes were made.

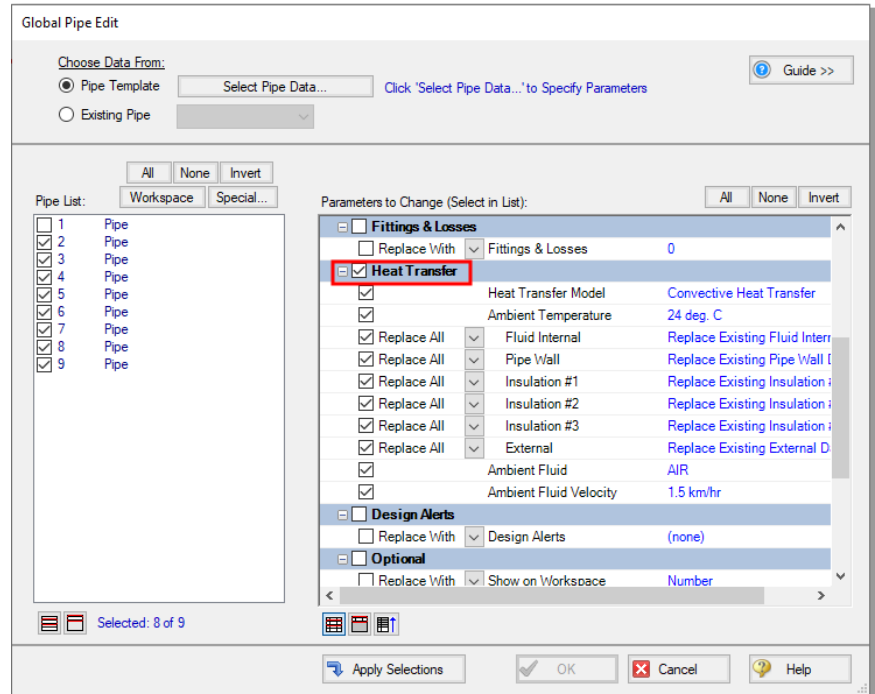

Figure 3.4 Global Pipe Edit window showing the parameters to be applied to all pipes selected in the Pipe List

C. Enter the junction data

J1 Tank

1. Enter the Name as Atmosphere
2. Elevation = 0 meters
3. Pressure = 0 barG
4. Temperature = 45 deg. C

J2 Compressor

1. Elevation = 0 meters
2. Select Centrifugal Compressor and set the Compressor Model to Curve
3. Choose Stagnation for the Added Pressure type
4. Set the Compression Process Thermodynamics to “Determine From Efficiency Data”
5. Select the Enter Curve Data button. Enter the Compressor Curve pressure and efficiency data from the following table into the Raw Data table in the Compressor Configuration window that is shown in Figure 3.5

m' (kg/sec)	dP (kPa)	Efficiency (percent)
0	83	80
0.25	69	80
0.5	41	80

6. After the curve data is entered in the Raw Data table, select the Pressure Rise and Efficiency check boxes in the curve fitting section of the Compressor Configuration window (see Figure 3.5). This will cause curve fits for both pressure and efficiency to be calculated. Then, click the Generate Curve Fit Now button to generate the Compressor Performance graph (see Figure 3.6). Select the OK button on the Compressor Configuration window to accept the Compressor curve fit and to close the window. Select the OK button to close the Compressor/Fan Properties window.

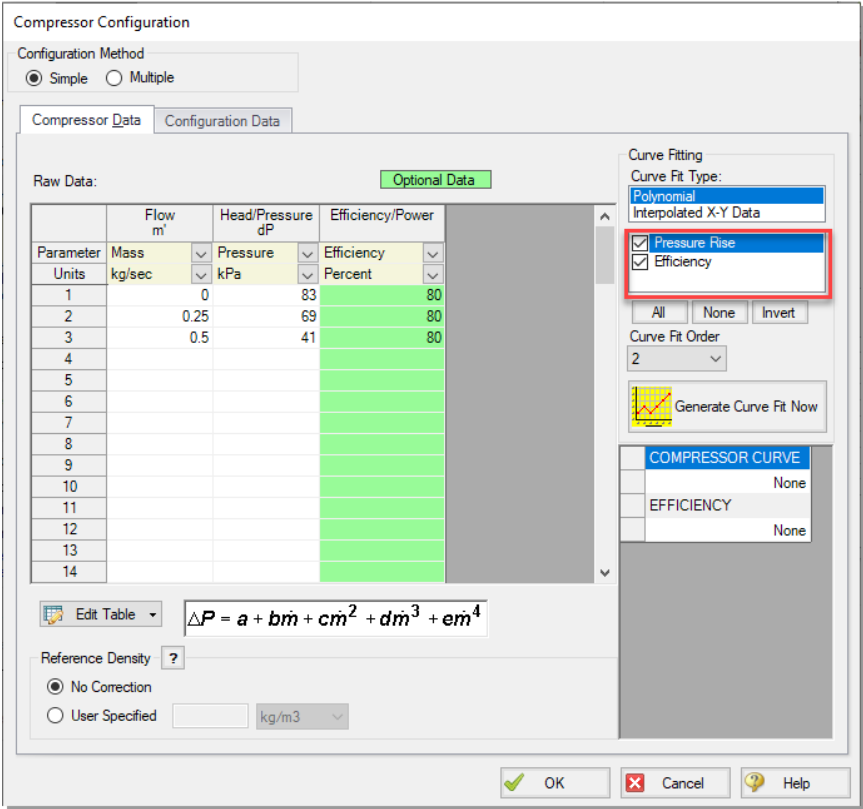

Figure 3.5 The Compressor Configuration window is where performance data is entered and fitted with a curve

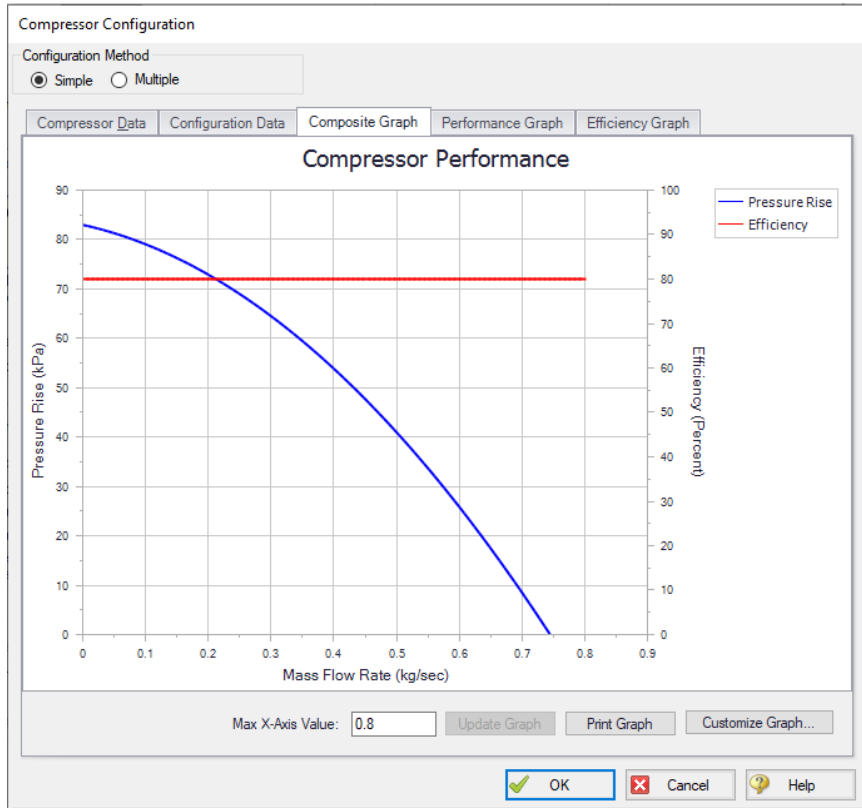

Figure 3.6 Compressor Configuration window Composite Graph tab showing plots of curve fits generated from the Raw Data table

J3 - J6 Branches

1. Open the Branch Properties window and enter an elevation of 0 meters for all of the Branch junctions.

J7 Valve (Tool #1)

1. Enter the Name as Tool #1
2. Elevation = 0 meters
3. Set the Loss Source to User Specified
4. Set the Loss Model to Resistance Curve

5. Check the optional Exit Valve box
6. Exit Pressure = 0 barG
7. Exit Temperature = 21 deg. C
8. Click the Enter Resistance Curve Data button. Set the Flow Parameter to Mass flow in kg/sec and the Head/Pressure Parameter to Pressure in kPa. Enter 0.1 kg/sec and 55 kPa in the proper columns of the Raw Data table, then click the Fill As Quadratic button to generate the resistance curve data. Then click the Generate Curve Fit Now button to generate the resistance curve. Click the OK button to accept the curve fit and to close the Valve Loss Curve Fit window and Valve Properties window.

J8, J9, and J10 Valves (Tool #2, Tool #3, and Tool #4)

1. For the J8 Valve, open the Valve Properties window, and select J7 (Tool #1) from the Copy Data From Jct list. This will open the Copy Data From Junction window. Click the All button. This will mark all of the properties for J8 to be set the same as the properties for J7. Since you want the J8 tool to retain its unique name, click on the check box next to the Name parameter to deselect it (see Figure 3.7). Click the OK button. J8 now has all of the same properties as J7, with the exception of its name.
2. Enter the name as Tool #2.
3. Repeat this process for J9 and J10, entering names of Tool #3 and Tool #4, respectively.

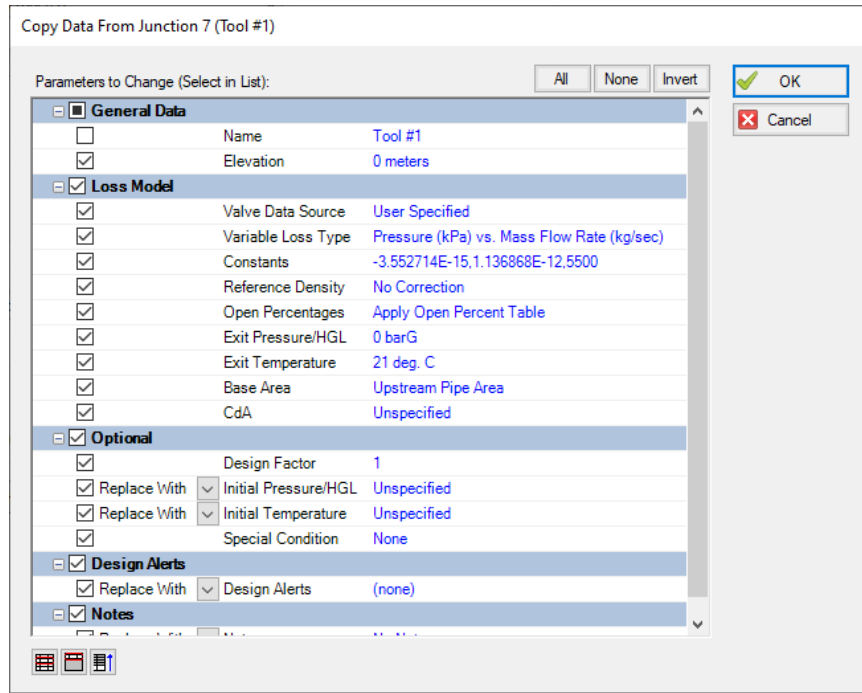

Figure 3.7 The Copy Data From Junction window allows you to copy selected data from one junction to another

D. Check if the pipe and junction data is complete

Check the Model Status light in the bottom-right of the Quick Access Panel. A green light at this point indicates a fully defined model. A red light indicates undefined pipes or junctions in the model. If this happens, go back to the incomplete pipes or junctions and enter the missing parameters. Alternatively, open the List Undefined Objects window from the View menu to see the undefined objects.

Note: Optionally, you can create a layer named Valve Labels with the valves set to visible within the Show/Hide Labels group in Layer Settings and the parameters Junction Name and Temperature Static Inlet selected in Junction Parameters.

Step 3. Create scenarios for the extreme temperature cases

For this problem, you are required to determine the temperature extremes at the tools based on the range of system specifications. To do this, you will use the Scenario Manager to examine the hot and cold extremes for the system.

The Scenario Manager is a powerful tool for managing variations of a model, referred to as *scenarios*. The Scenario Manager allows you to:

- Create, name, and organize scenarios
- Select the scenario to appear in the Workspace (the current scenario)
- Delete, copy, and rename scenarios
- Duplicate scenarios and save them as separate models
- Review differences between scenarios using the Scenario Comparison Tool
- Propagate changes from a parent scenario to its children

Create two scenarios to model these cases. Access the Scenario Manager from the Quick Access Panel, which is located on the right side of the Workspace area, or from the Tools menu. A scenario tree displays all model scenarios.

Click the Create Child button on the Quick Access Panel, or from the right-click menu on the Base Scenario (see Figure 3.8). Name the child “Hot Case”. A new scenario will appear below the Base Scenario in the scenario tree, and it will be automatically selected and loaded. Select the Base Scenario, create another child, and call it “Cool Case” (see Figure 3.8).

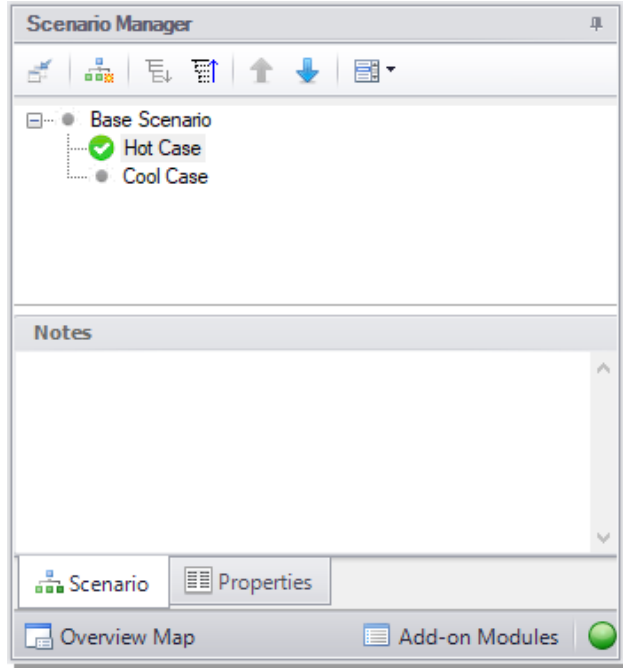

Figure 3.8 Create model variants and keep them organized using the Scenario Manager on the Quick Access Panel

Step 4. Set up the Hot Case scenario

The Base Scenario contains all of the basic information for the model, such as the pipe and junction layout, pipe lengths, system properties, etc.

Child scenarios inherit data from their ancestors. As long as the data has not been modified in a child scenario, parameters in the child scenario will have the same value as their parent. We will modify the system conditions to simulate the case that will result in the hottest temperature at the tools.

Double-click the “Hot Case” scenario in the scenario tree of the Scenario Manager on the Quick Access Panel. This loads the “Hot Case” scenario onto the Workspace as the current scenario. The currently loaded scenario is displayed in the scenario tree with a green circle and a white check mark (Figure 3.8). Alternatively, you can use

the Scenario Manager window from the Tools menu to load the scenario.

In order to simulate the highest temperature case at the tools, you need to decide which design requirements will result in the highest tool temperatures. This will occur for the highest inlet and ambient temperatures for the air, and the heat transfer properties of the piping which will result in the least amount of heat loss.

Check the following model information as indicated:

J1 Tank (Atmosphere)

1. Set the tank temperature at the highest value of 45 deg. C.

J2 Compressor

1. The compressor will generate more heat if it is less efficient. Since this is the high temperature case, you should assume the worst possible efficiency, which is 80%. This data is entered on the Compressor/Fan Configuration window. Since you used 80% in the table when you added the Compressor information in the Base Scenario, the compressor in this scenario has already inherited the Compressor curve for 80% efficiency. Make no changes to the compressor in this scenario.

Pipes P2-P9

1. The heat transfer properties of the uninsulated pipes (P2-P9), should be set to the values which will minimize the heat transfer occurring in the pipe, and result in the highest temperature at the tools.
2. For this case, you should use the highest ambient temperature of 24 deg. C and minimum velocity of 1.5 km/hr which will yield the lowest heat loss. Since you used this same data when you added the pipe heat transfer data in the Base Scenario using the Global Pipe Edit feature, the pipes in this scenario have already inherited this heat transfer data, so no change in the heat transfer data is necessary. To verify this, click on Pipe P2 to open the Pipe Properties window. Select the Heat Transfer tab. The data should appear the same as shown in Figure 3.3.

Step 5. Run the the Hot Case scenario

Select “Run Model” from the Common Toolbar or in the Analysis menu. The Solution Progress window opens and begins iterating. This window displays the AFT Arrow Solver converging on the answer. After the Solver converges, view the results by clicking Output at the bottom of the Solution Progress window.

The output for the Hot Case scenario is shown in Figure 3.9. The junction output table shows the highest inlet static temperature at the tools for the Hot Case is 93.5 deg. C.

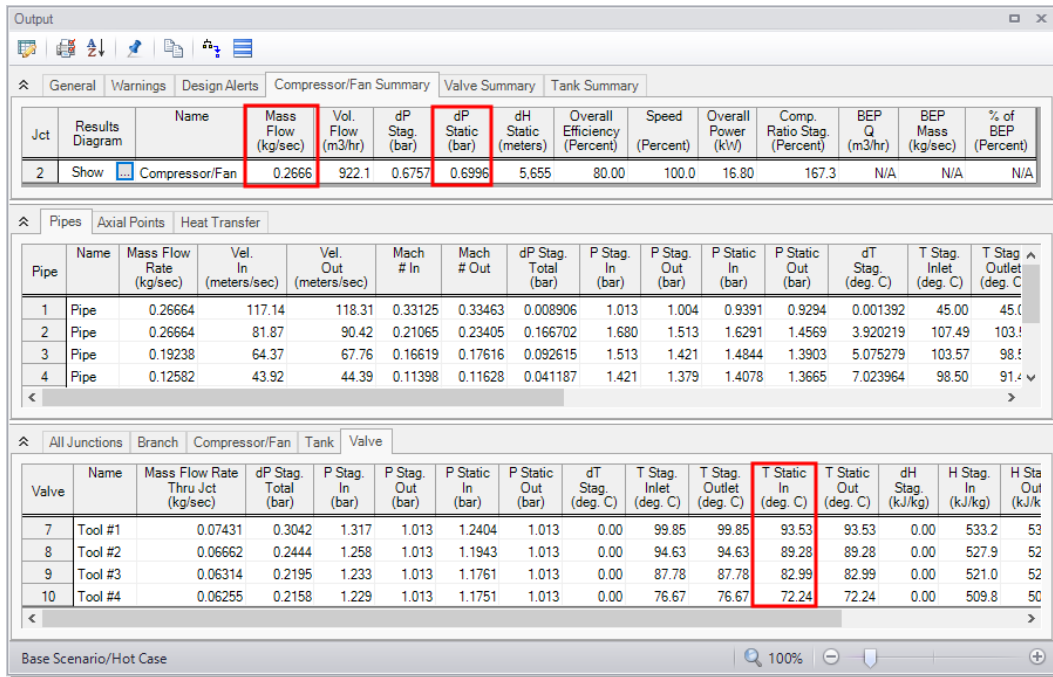

Figure 3.9 Output window for the Hot Case scenario

When compressors/fans are included in a model, AFT Arrow gathers the related data together in one convenient location in the Output window. This information can be found on the Compressor/Fan Summary tab located in the General Output section of the Output window, as shown at the top of Figure 3.9.

From Figure 3.9, the Compressor/Fan Summary shows that the compression requirement is 0.70 bar, and the mass flow is 0.27 kg/sec.

The Compressor/Fan Summary can also be displayed in a Results Diagram, as shown in Figure 3.10, by selecting the button next to “Show” in the Results Diagram column, double-clicking anywhere in the row, or right-clicking anywhere in the row and selecting Results Diagram.

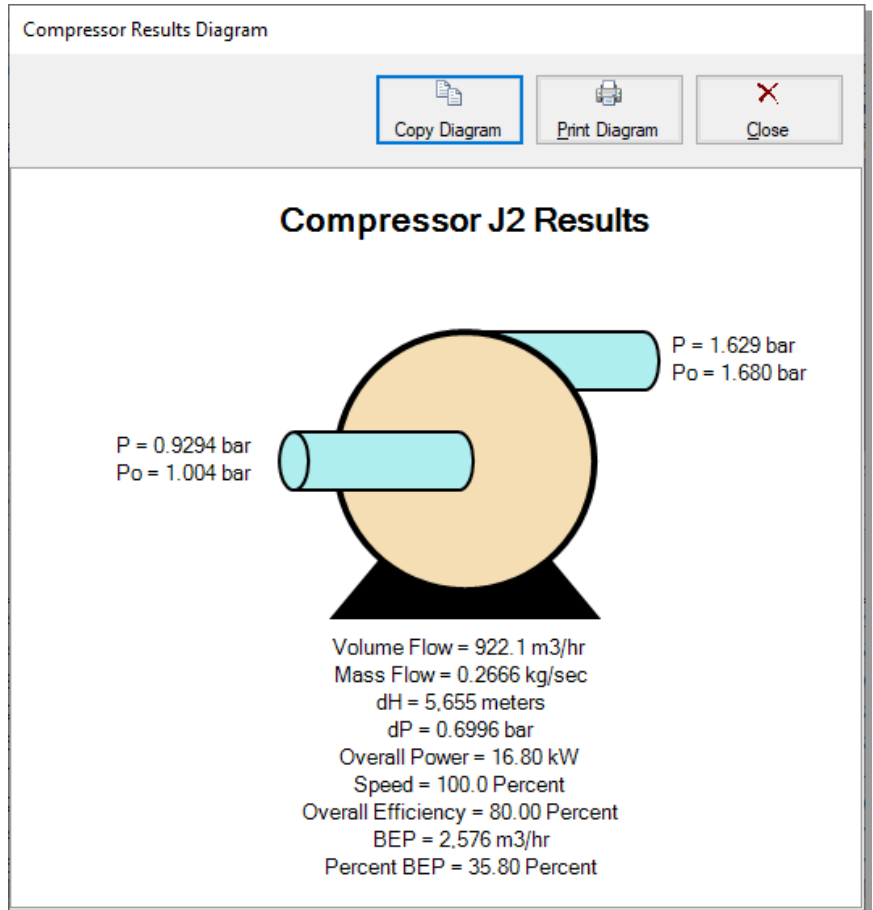

Figure 3.10 Compressor Results Diagram

The pipe heat transfer results from the Heat Transfer tab (see Figure 3.11) can also be displayed in a Results Diagram, as shown in Figure

3.12, by selecting the button next to “Show” in the Results Diagram column, double-clicking anywhere in the row, or right-clicking anywhere in the row and selecting Results Diagram.

The screenshot shows a software interface with three tabs: Pipes, Axial Points, and Heat Transfer. The Heat Transfer tab is active, displaying a table with the following data:

Pipe	Results Diagram	Name	T Fluid Inlet (deg. C)	T Fluid Outlet (deg. C)	T Inlet Wall Inside (deg. C)	T Outlet Wall Inside (deg. C)	T Inlet Outer Wall (deg. C)	T Outlet Wall Outside (deg. C)	T Ambient (deg. C)
1	Show	Pipe	38.17	38.03	N/A	N/A	N/A	N/A	N/A
2	Show	Pipe	104.18	99.54	105.22	101.40	105.16	101.34	24.00
3	Show	Pipe	101.53	96.23	100.65	95.75	100.59	95.70	24.00
4	Show	Pipe	97.55	90.50	94.50	87.84	94.45	87.80	24.00
5	Show	Pipe	91.24	79.54	84.96	74.36	84.92	74.33	24.00
6	Show	Pipe	98.80	93.53	101.12	97.51	101.05	97.44	24.00
7	Show	Pipe	94.29	89.28	95.96	92.22	95.89	92.16	24.00
8	Show	Pipe	87.63	82.99	89.05	85.49	88.99	85.44	24.00
9	Show	Pipe	76.17	72.24	77.74	74.76	77.69	74.71	24.00

Figure 3.11 The Heat Transfer tab in the Output window shows detailed heat transfer results for pipes

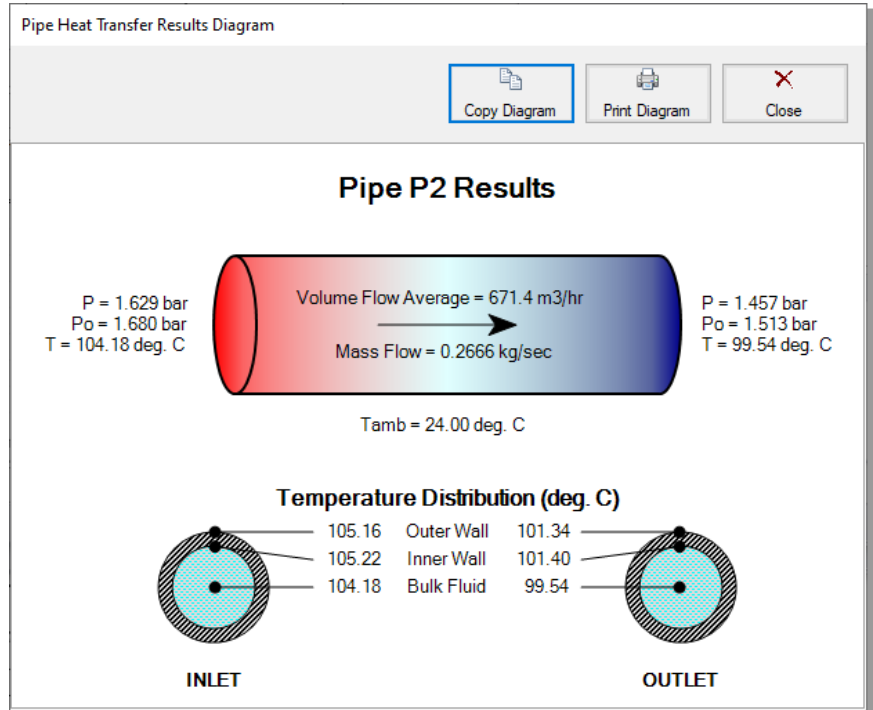

Figure 3.12 Pipe Heat Transfer Results Diagram

Step 6. Graph the Results

AFT Arrow allows you to create *dual y-axis graphs*, which plot two parameters on the same graph.

In this example, you will graph the static temperature and the static pressure from the J1 Tank through the pipeline to Tool 4 (J10) on a dual y-axis graph to help you understand how the temperature and pressure change as the air flows through the pipeline.

Note: You can repeat this process for the flow path from the J1 Tank to the other tools, or you can graph the flow through each path on this same graph using the Plot Multiple Paths Using Groups feature.

1. From the Graph Results window, in the Graph Control tab, choose the Profile tab in the Parameters/Formatting area, specify Plot

Single Path in the Pipes definition area, then select pipes P1-P5 and P9. These pipes make up the path from the J1 Tank junction to Tool 4.

2. Ensure that meters are selected for the Length Units.

You will need to decide what parameter you wish to plot on the primary y-axis and which parameter you want to plot on the secondary y-axis. In this example, we will plot static pressure on the primary y-axis and static temperature on the secondary y-axis.

3. To do this, select Pressure Static in the Parameters definition area and choose bar as the static pressure unit.
4. Add a parameter by clicking on the Add button next to Select Parameter in the Parameters definition area.
5. Change this added parameter to Temperature Static and choose deg. C as the unit.
6. To specify that the temperature will be plotted on the secondary y-axis, first select this parameter by clicking on the box to the left of Temperature Static, then click on the Make Secondary Y-Axis icon (this is the blue, right arrow icon located at the top-right over the selected parameters). Alternatively, you can double-click on the box to the left of Temperature Static in the Parameters definition area. Note that Temperature Static becomes indented under Pressure Static, and that the black arrow next to Temperature Static turns to point towards the left. See Figure 3.13 to see how these graphing parameters are defined.

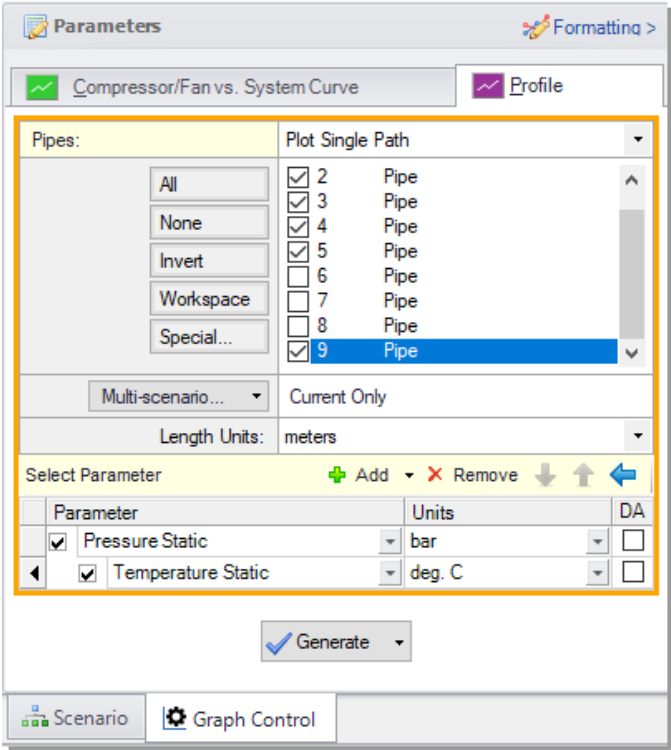

Figure 3.13 Parameter definition for a dual y-axes graph of static pressure (primary y-axis) and static temperature (secondary y-axis) on the Graph Control tab on the Quick Access Panel

Click the Generate button. You will see that the static pressure and temperature increase after the air flows through the compressor, and then these parameters gradually drop as the air flows through the pipes and to each tool. See Figure 3.14 for this graph.

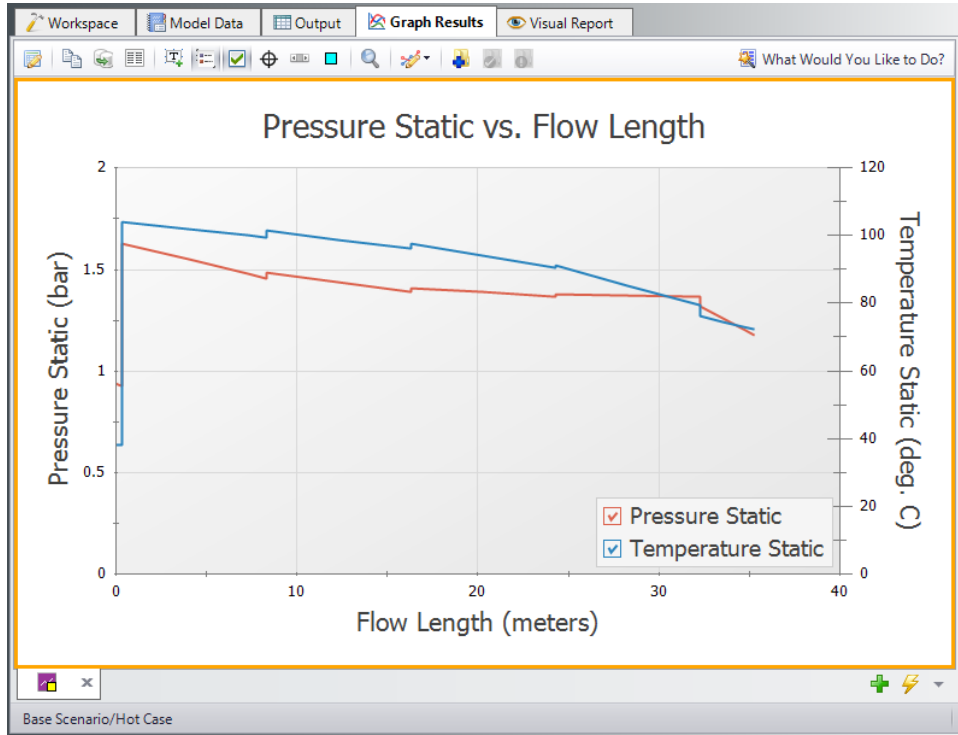

Figure 3.14 Pressure and temperature from the J1 Tank junction to Tool 4 (J10) plotted on a dual y-axis graph

Step 7. Set up the Cool Case scenario

Double-click the “Cool Case” scenario in the list in the Scenario Manager on the Quick Access Panel. This will load the “Cool Case” scenario onto the Workspace as the current scenario.

In order to simulate the coolest temperature case, you must assume the lowest inlet and ambient temperatures, and the heat transfer properties for the piping that result in the largest amount of heat transfer.

Modify the following model information as indicated:

J1 Tank (Atmosphere)

1. Set the temperature to the lowest value of -18 deg. C.

J2 Compressor

1. The compressor will generate less heat if it is more efficient. Since this is the lower temperature case, we will assume the best possible efficiency of 90%. This data is entered on the Compressor/Fan Configuration window. When you added the compressor information in the Base Scenario, the efficiency was entered in the table as 80%. Change the efficiency in the table to 90% for each row. Select only Efficiency under Curve Fitting, and then click the Generate Curve Fit Now button to generate a new efficiency curve. Close the Compressor Configuration and Properties windows by selecting the OK button.

Pipes P2-P9

1. Set the heat transfer properties of the uninsulated pipes downstream of the compressor (P2-P9) to the values that will result in the lowest gas temperatures at the tools. The appropriate ambient temperature to use is the lowest of 21 deg. C. However, it is not clear which convection coefficient should be used. If the heat of compression at the compressor heats the gas to a temperature higher than 21 deg. C, we should use the highest ambient air velocity of 25 km/hr. This will permit maximum cooling of the gas in the pipe. On the other hand, if the compressor discharge temperature is less than 21 deg. C, then the lowest ambient air velocity of 1.5 km/hr should be used. This will yield the least heating of the gas in the pipes, giving the lowest possible temperature at the tools. Here we will use the value of 25 km/hr. As just discussed, in practice one would need to verify the validity of this assumption.
2. Use the Global Pipe Edit feature to change the heat transfer properties in Pipes P2-P9. Set the Ambient Temperature to 21 deg. C, and set the Fluid Velocity to 25 km/hr. Also, ensure that the Gnielinski correlation is selected under the Convection Coefficient column in the Fluid Internal row, and that Forced (Churchill-Bernstein) is selected in the External row.

Step 8. Run the Cool Case scenario

Select “Run Model” from the Common Toolbar or in the Analysis menu. When the solution has converged, view the results by clicking on the Output button at the bottom of the Solution Progress window.

The output for the Cool Case scenario is shown in Figure 3.15. The junction output table shows the lowest inlet static temperature at the tools for the Cool Case is 18.5 deg. C. Note that the compressor discharge stagnation temperature is 26.1 deg. C (T Stag Inlet for P2 in Figure 3.15), and thus the assumption of 25 km/hr for the air velocity is appropriate.

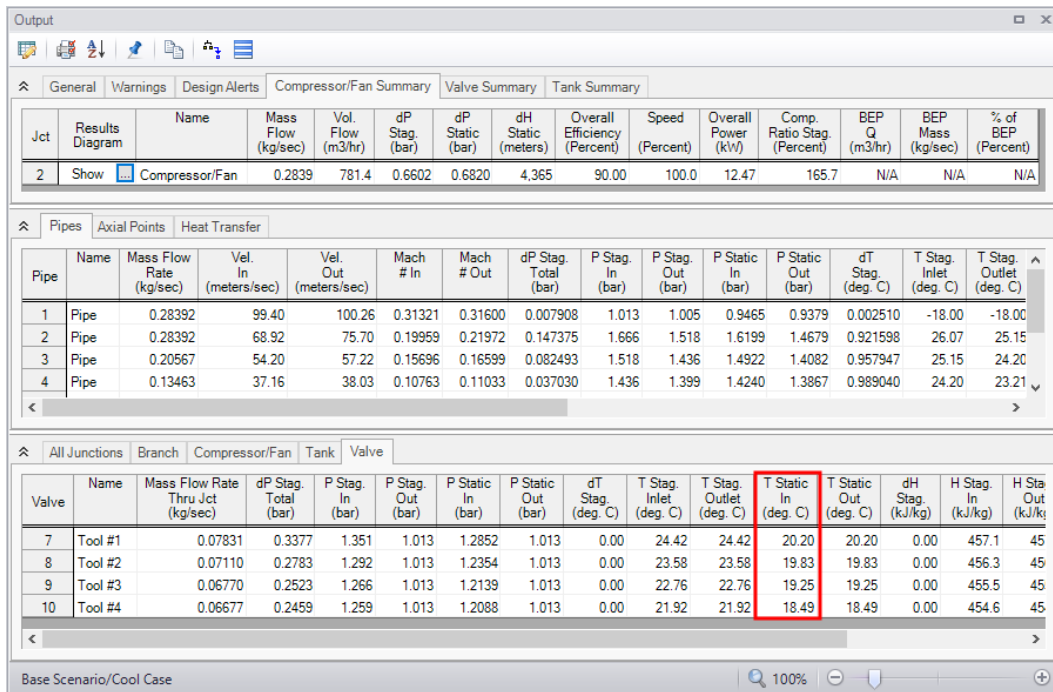

Figure 3.15 Output window for the Cool Case scenario

Analysis summary

By carefully selecting the input parameters from the specified system parameters, you were able to use AFT Arrow to determine the

temperature extremes of the gas being supplied to the tools in a compressed air system. The temperature extremes of 18.5 deg. C to 93.5 deg. C can now be sent to the tool manufacturer, who will use it to compensate for the temperature sensitivity of the tools.

Isometric Pipe Drawing Mode

AFT Arrow uses a 2D grid by default for objects on the Workspace, as was the case with this example.

Figure 3.16 shows the compressed air system with the 2D grid displayed (select Show Grid from the Arrange menu).

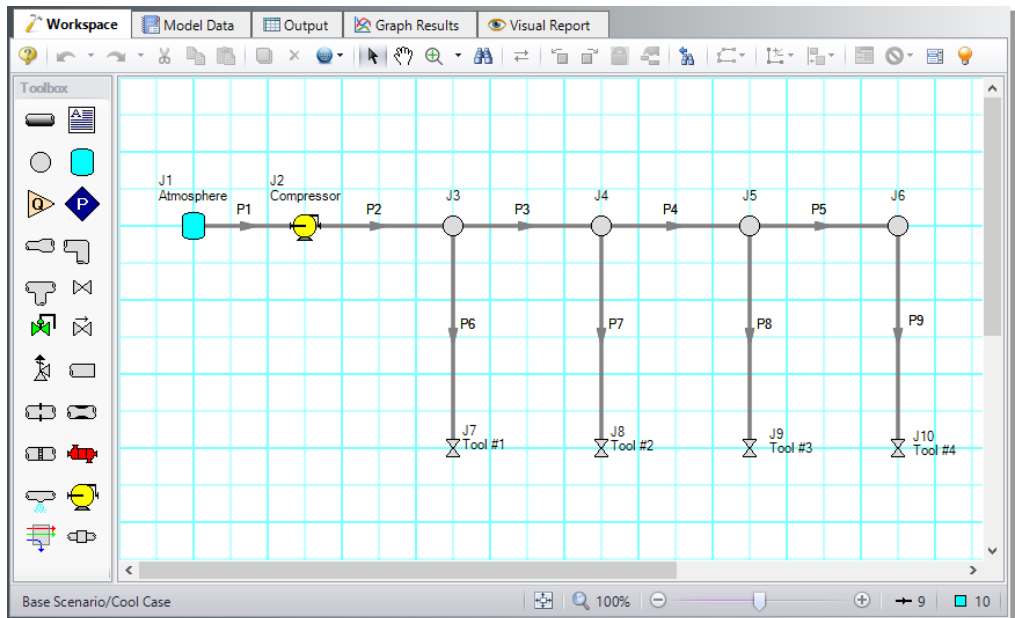

Figure 3.16 Compressed air system with the 2D grid shown

At times it may be convenient to demonstrate the three-dimensional nature of a system. For example, you may be building a model based on isometric reference drawings. AFT Arrow includes an Isometric Pipe Drawing Mode for these cases. The isometric grid has three gridlines that are offset by 60°, representing the x, y, and z axes. Figure 3.17 shows the compressed air system built on an isometric grid.

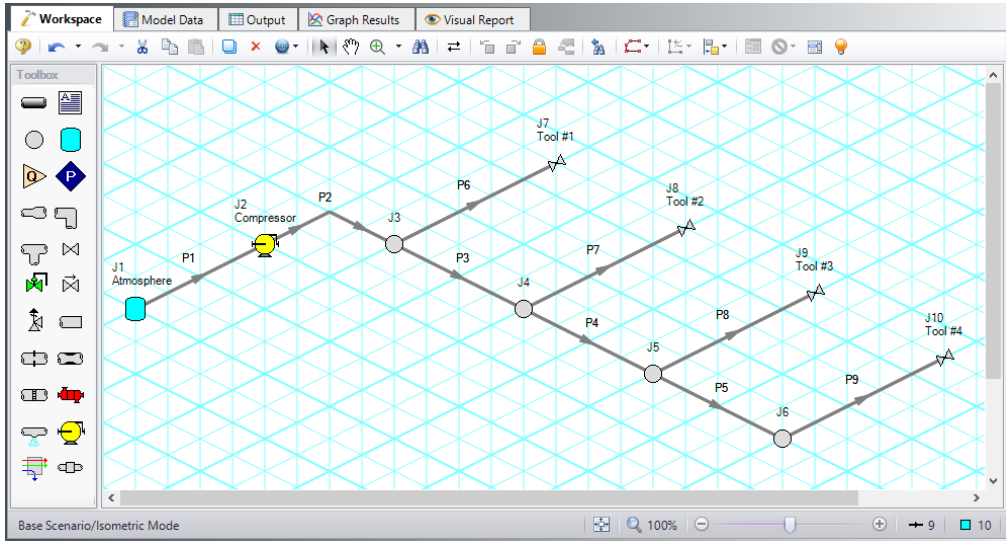

Figure 3.17 Compressed air system with the isometric grid shown

You can enable the isometric grid by going to the Arrange menu from the Workspace. Under Pipe Drawing Mode, there are three options: 2D Freeform (default), 2D Orthogonal, and Isometric.

- **Create the compressed air system on an isometric grid to see how to use this feature.**
 1. Go to the File menu and select New.
 2. From the Arrange menu, choose Show Grid.
 3. From the Arrange menu again, go to Pipe Drawing Mode and select Isometric.
 4. Place junctions J1-J7 on the Workspace in the positions shown in Figure 3.17.
 5. You will notice that placing junctions onto the Workspace follows the usual rules, however, the visual appearance of the icons can be more complex than on a 2D grid. Due to the increased number of axes, the preferred icon and rotation can be selected to obtain visual consistency. Right-click on J7 and select Customize Icon. Select the icon shown in Figure 3.18.

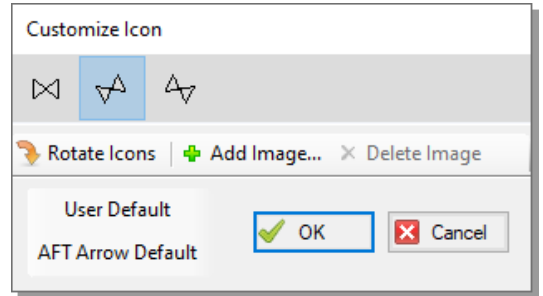

Figure 3.18 Right click on the junction to open the **Customize Icon** window and select the preferred settings

6. Select J7 and duplicate the junction three times to create junctions J8-J10 using any of the following methods: CTRL+D keyboard shortcut, icon on the Workspace Toolbar, Edit menu, or right-click context menu. Duplicating the junction which will retain the preferred icon.
7. Draw Pipe P1 as shown in Figure 3.19.
8. Draw Pipe P2 from J2 to J3. A red-dashed preview line will show how the pipe will be drawn on the isometric grid. As you are drawing a pipe, you can change the preview line by clicking any arrow key on your keyboard or scrolling the scroll wheel on your mouse. Figure 3.19 shows Pipe P2 being drawn with the preview line.

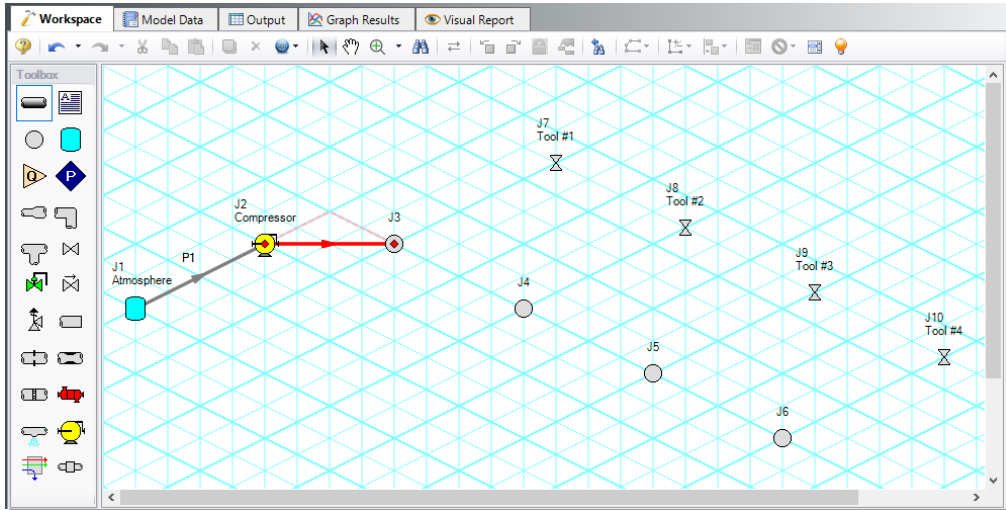

Figure 3.19 A preview line shows when drawing or adjusting pipes in the Isometric Drawing Mode

Note: You can hold the ALT key while adjusting a pipe by the endpoint to add an additional segment. This can be used with the arrow key or mouse scroll wheel to change between different preview line options.

9. Draw Pipes P3-P9 as shown in Figure 3.20.
10. The grid can be shown or turned off in the Arrange menu.

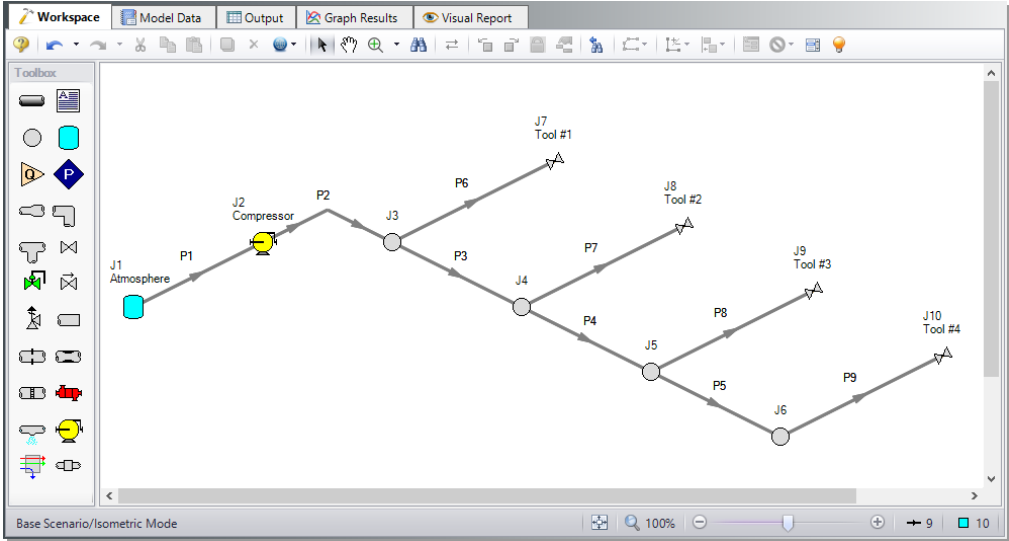

Figure 3.20 Compressed air system with isometric grid not shown

Natural Gas Burner System Example

This example demonstrates how to size a heat exchanger to deliver natural gas at a minimum required temperature.

Topics covered

- Sizing a heat exchanger for a particular system
- Entering a loss curve for a heat exchanger
- Specifying heat transfer data for pipes
- Using flow control valves

Required knowledge

This example assumes that the user has some familiarity with AFT Arrow such as placing junctions, connecting pipes, and entering pipe and junction properties. Refer to the example in Chapter 2 for more information on these topics.

Model file

A completed version of the model file can be referenced from the Examples folder as part of the AFT Arrow installation:

C:\AFT Products\AFT Arrow 10\Examples

- *Metric - Natural Gas Burner.aro*

Problem statement

An underground storage reservoir containing natural gas made up mostly of methane supplies gas to five burners. The gas source is at 34.5 barG, and 10 deg. C. The gas is supplied to each of the burners at 6.9 barG. To assure that the flow to each of the burners is equal, each burner has a control valve that controls the flow to 2.25 kg/sec.

The pipes in the system are uninsulated STD (schedule 40) steel pipes, with standard roughness. The ambient temperature surrounding the pipes is 24 deg. C, with an air velocity of 25 km/hr.

In order to operate at the best efficiency, the gas should be delivered to the burners at a minimum stagnation temperature of 38 deg. C. To achieve this, the gas flows through a heat exchanger which has a 70 kPa pressure drop at 11 kg/sec.

How much heat must be added by the heat exchanger to ensure that all of the burners will receive gas at the specified minimum temperature? Elevation changes can be neglected.

Step 1. Specify fluid properties

1. Open Analysis Setup from the Common Toolbar or the Analysis menu.
2. Under the Fluid Properties group, click the Fluid item to open the Fluid panel, if not already open. Select the AFT Standard library and then select “Methane” in the “Fluids Available in Library” list.
3. Click “Add to Model” to select methane for use in this model.

4. Use the default “Redlich-Kwong” for the equation of state and “Generalized” for the enthalpy model.
5. Click OK to save and close Analysis Setup.

Step 2. Build the model

A. Place the pipes and junctions

This completes the first two groups of the Analysis Setup. The Pipes and Junctions group remains undefined. To complete this group, begin by assembling the model on the Workspace as shown in Figure 4.1.

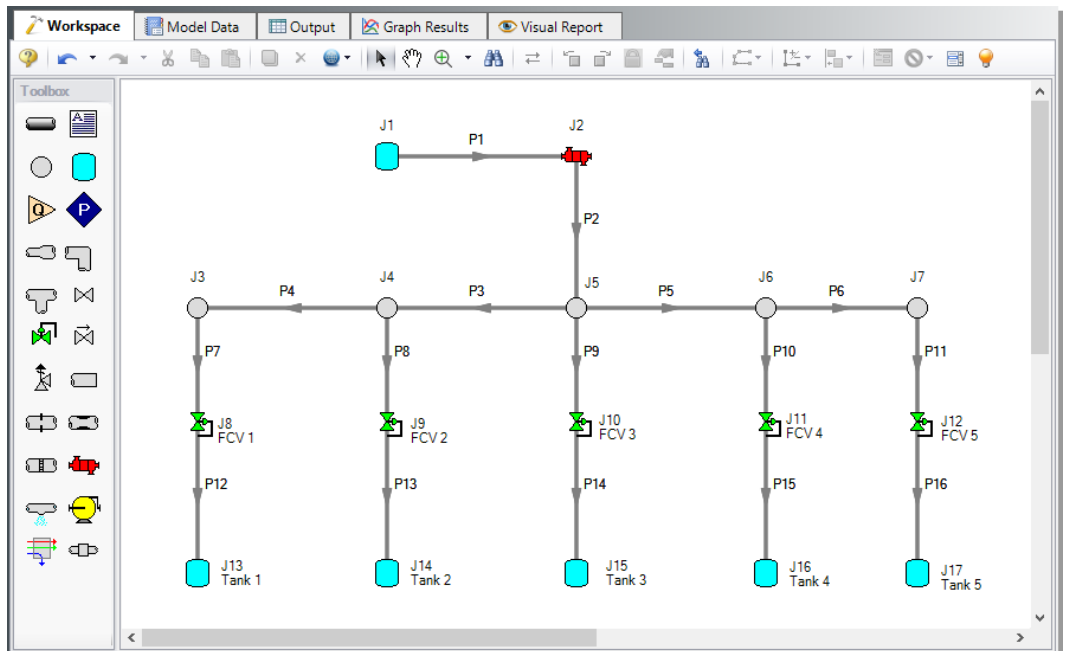

Figure 4.1 Layout of the pipe system for the Natural Gas Burner System Example

B. Enter the pipe data

With the objects in place, define the input data for the pipes and junctions. Double-click each pipe and enter the following data in the

Properties window (or use the Global Pipe Edit window, as discussed in Chapter 3).

All of the pipes are Steel - ANSI, STD (schedule 40), with the Standard friction model and the following data:

Pipe	Length (meters)	Nominal Size
P1	30	4 inch
P2 - P6	6	4 inch
P7 - P16	1.5	3 inch

Enter the following data on the Heat Transfer tab for each pipe, as shown for Pipe P1 in Figure 4.2:

1. Heat Transfer Model = Convective Heat Transfer
2. Ambient Temperature = 24 deg. C
3. Fluid Velocity = 25 km/hr
4. Fluid = Air

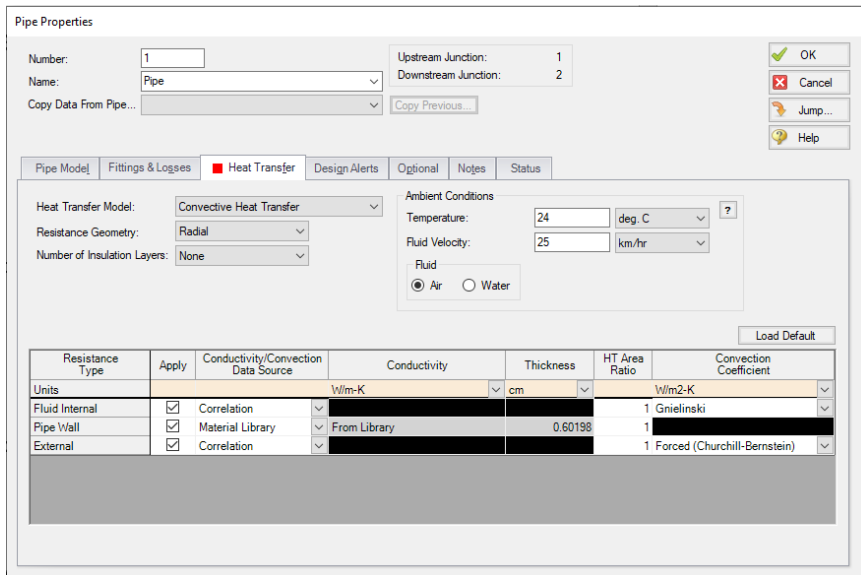

Figure 4.2 Pipe Heat Transfer properties to be applied to all pipes

C. Enter the junction data

J1 Tank (Supply Reservoir)

1. Elevation = 0 meters
2. Pressure = 34.5 barG
3. Temperature = 10 deg. C

J2 Heat Exchanger

1. Elevation = 0 meters
2. Enter Loss Model Data
 - a. Select the Loss Model as “Resistance Curve”, and then click the “Enter Curve Data” button
 - b. Select “Mass” as the Flow Parameter
 - c. Enter 11 kg/sec and 70 kPa in the Raw Data table
 - d. Click the “Fill As Quadratic” button to generate data for the loss curve
 - e. Select “Generate Curve Fit Now” to create a quadratic curve fit
 - f. Click OK to close the Heat Exchanger Loss Curve Fit window

To solve this problem, you will have to make an initial guess for how much heat to add to the heat exchanger, examine the results, and adjust the heat added until you achieve the desired minimum temperature at the burners. To do this, select the Thermal Data tab on the Heat Exchanger Properties window, and select the Thermal Model as "Specified Heat Rate In Constant". Then enter a value for Heat Flow Into System. For the first guess, use 500 kW.

J8 - J12 Flow Control Valves

1. Elevation = 0 meters
2. Valve Type is Flow Control (FCV)
3. Control Setpoint, Mass Flow Rate = 2.25 kg/sec

J13 - J17 Tanks (Burners)

1. Elevation = 0 meters
2. Pressure = 6.9 barG (690 kPa(g))
3. Temperature = 260 deg. C

J3 - J7 Branches

1. Elevation = 0 meters

D. Check if the pipe and junction data is complete

Check the Model Status light in the bottom-right of the Quick Access Panel. A green light at this point indicates a fully defined model. A red light indicates undefined pipes or junctions in the model. If this happens, go back to the incomplete pipes or junctions and enter the missing parameters. Alternatively, open the List Undefined Objects window from the View menu to see the undefined objects.

Step 3. Run the model

Select “Run Model” from the Common Toolbar or in the Analysis menu. The Solution Progress window opens and begins iterating. This window displays the AFT Arrow Solver converging on the answer. After the Solver converges, view the results by clicking Output at the bottom of the Solution Progress window.

Step 4. Examine the results

Examination of the stagnation temperature at the outlets of the pipes discharging to the burners shows that the lowest temperature is 16.93 deg. C (see Pipe P16 in Figure 4.3). This is well below the required minimum temperature of 38 deg. C. The heat added to the heat exchanger must be increased, and the model must be run again to determine the outlet temperature at the new value.

Step 5. Manually iterate the heat rate

By trial and error, you will find that you need to add 1052 kW to the heat exchanger to achieve a minimum stagnation temperature of 38 deg. C.

Analysis summary

Using AFT Arrow, you were able to determine the amount of heat required by the heat exchanger to supply natural gas to the burners at the minimum required temperature.

The goal seeking capabilities in the optional AFT Arrow GSC Add-on Module would allow this problem to be solved directly without manual iteration. The variable would be specified as the heat exchanger heat rate, and the goal would be the minimum discharge pipe exit temperature.

More discussion on the GSC Add-on Module is given in Chapter 5.

Jct	Name	Mass Flow (kg/sec)	dP Stag. (bar)	dP Static (bar)	dT Static (deg. C)	T Static Inlet (deg. C)	T Static Outlet (deg. C)	Heat Rate In (kW)	T Stag 2nd Inlet (deg. C)	T Stag 2nd Outlet (deg. C)
2	Heat Exchanger	11.25	0.7322	0.7739	-18.03	8.767	26.80	500.0	N/A	N/A

Pipe	Name	Mass Flow Rate (kg/sec)	Vel. In (meters/sec)	Vel. Out (meters/sec)	Mach # In	Mach # Out	dP Stag. Total (bar)	P Stag. In (bar)	P Stag. Out (bar)	P Static In (bar)	P Static Out (bar)	dT Stag. (deg. C)	T Stag. Inlet (deg. C)	T Stag. Outlet (deg. C)
5	Pipe	4.500	24.80	24.85	0.05818	0.05829	0.06555	32.569	32.503	32.501	32.435	0.04795	27.55	27.500
6	Pipe	2.250	12.41	12.42	0.02910	0.02912	0.01647	32.503	32.487	32.486	32.470	0.04951	27.53	27.477
7	Pipe	2.250	21.40	21.41	0.05018	0.05021	0.01697	32.487	32.470	32.436	32.419	0.01590	27.46	27.444
8	Pipe	2.250	21.39	21.40	0.05016	0.05019	0.01697	32.503	32.486	32.453	32.436	0.01600	27.51	27.493
9	Pipe	2.250	21.35	21.36	0.05007	0.05009	0.01694	32.569	32.552	32.519	32.502	0.01611	27.56	27.541
10	Pipe	2.250	21.39	21.40	0.05016	0.05019	0.01697	32.503	32.486	32.453	32.436	0.01600	27.51	27.493
11	Pipe	2.250	21.40	21.41	0.05018	0.05021	0.01697	32.487	32.470	32.436	32.419	0.01590	27.46	27.444
12	Pipe	2.250	89.24	90.11	0.20474	0.20672	0.07302	7.986	7.913	7.774	7.698	0.01424	16.94	16.928
13	Pipe	2.250	89.26	90.13	0.20476	0.20674	0.07303	7.986	7.913	7.774	7.698	0.01438	16.99	16.974
14	Pipe	2.250	89.27	90.13	0.20477	0.20675	0.07303	7.986	7.913	7.774	7.698	0.01444	17.01	16.998
15	Pipe	2.250	89.26	90.13	0.20476	0.20674	0.07303	7.986	7.913	7.774	7.698	0.01438	16.99	16.974
16	Pipe	2.250	89.24	90.11	0.20474	0.20672	0.07302	7.986	7.913	7.774	7.698	0.01424	16.94	16.928

Figure 4.3 Output for the Natural Gas Burner System Example

AFT Arrow Add-on Modules Examples

This chapter covers two examples. The first example demonstrates how to use the Goal Seek & Control (GSC) Add-on Module, and the second demonstrates how to use the Extended Time Simulation (XTS) Add-on Module.

A separate Quick Start Guide covers the Automated Network Sizing (ANS) Add-on Module.

The user can only perform these examples if access to the relevant modules is available.

Topics covered

- GSC - Using the Goal Seek and Control Manager
- GSC - Defining Variables and Goals
- GSC - Using Group Max/Min Goals
- GSC - Linking Variables
- XTS - Specifying the Transient Control group
- XTS - Defining system transients
- XTS - Understanding Transient Output

Required knowledge

This example assumes that the user has some familiarity with AFT Arrow such as placing junctions, connecting pipes, and entering pipe and junction properties. Refer to the example in Chapter 2 for more information on these topics.

To model the heat transfer in these examples, the user may need to refer to Chapter 4 for more detailed explanations.

Model files

For your reference, see the completed model files for these examples installed in the Examples folder as part of the AFT Arrow installation:

C:\AFT Products\AFT Arrow 10\Examples

- *Metric - Process Steam System - GSC.aro*
- *Metric - Air Receiver Tank - XTS.aro*

GSC Problem statement

A process steam supply system has two boilers at 20.7 barG and 430 deg. C.

All of the pipes in the system have 5 cm of insulation with a thermal conductivity of 0.03 W/m-K. The ambient temperature is 24 deg. C with an average air velocity of 11 km/hr. The pipes are all Steel - ANSI, schedule 40. All of the elbows in the system are Smooth, with an r/D of 1.5.

Assume “Redlich-Kwong” for the equation of state model, and “Generalized” for the enthalpy model.

The system has six users with variable peak flow demands.

- User 1: 18,000 kg/hr
- User 2: 23,000 kg/hr
- User 3: 25,000 kg/hr
- User 4: 25,000 kg/hr

- User 5: 18,000 kg/hr
- User 6: 27,000 kg/hr

For the specified design flows, the process steam system must meet a minimum delivery pressure of 7 barG at each discharge.

GSC Step 1. Specify fluid properties

1. In the Analysis Setup window on the Fluid panel, select the AFT Standard library, and then select “Steam” in the Fluids Available in Library list
2. Click “Add to Model” to select steam for use in this model
3. Select the “Redlich-Kwong” equation of state option
4. Select the “Generalized” enthalpy model
5. Click the OK button

GSC Step 2. Build the model

A. Place the pipes and junctions

This completes the first two groups of the Analysis Setup. The Pipes and Junctions group remains undefined. To complete this group, begin by assembling the model on the Workspace as shown in Figure 5.1.

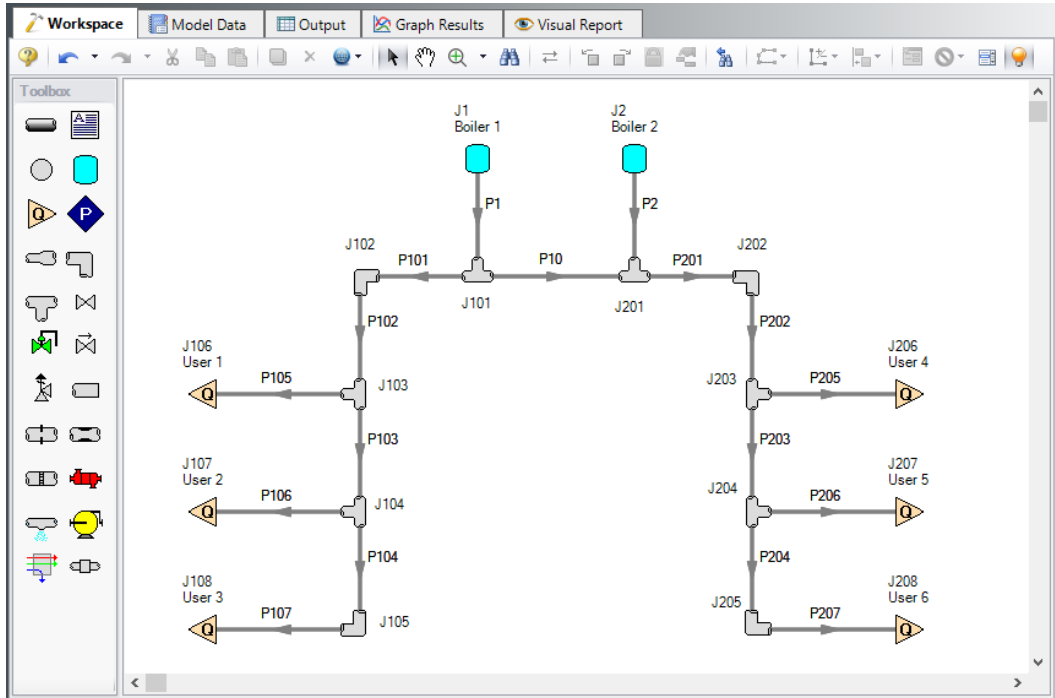

Figure 5.1 Layout of the pipe system for the Process Steam System Example

B. Enter the pipe data

With the objects in place, define the input data for the pipes and junctions. Double-click each pipe and enter the following data in the Properties window (or use the Global Pipe Edit window, as discussed in Chapter 3):

Pipe	Nominal Size	Type	Length (meters)
P1	12 inch	schedule 40	30
P2	12 inch	schedule 40	46
P10	12 inch	schedule 40	23
P101	8 inch	schedule 40	122
P102	8 inch	schedule 40	229
P103	8 inch	schedule 40	229
P104	8 inch	schedule 40	76
P105	6 inch	schedule 40	30
P106	6 inch	schedule 40	15
P107	6 inch	schedule 40	23
P201	8 inch	schedule 40	76
P202	8 inch	schedule 40	152
P203	8 inch	schedule 40	152
P204	8 inch	schedule 40	152
P205	6 inch	schedule 40	15
P206	6 inch	schedule 40	23
P207	6 inch	schedule 40	15

Enter the following data on the Heat Transfer tab for each pipe:

1. Heat Transfer Model = Convective Heat Transfer
2. Ambient Temperature = 24 deg. C
3. Fluid Velocity = 11 km/hr
4. Fluid = Air
5. Number of Insulation Layers = 1 External
6. Insulation #1 Conductivity = 0.03 W/m-K, Thickness = 5 cm

C. Enter the junction data

J1 and J2 Tanks

1. Elevation = 0 meters
2. Pressure = 20.7 barG
3. Temperature = 430 deg. C

J106 - J108 and J206 - J208 Assigned Flows

1. Elevation = 0 meters
2. Flow Rate = see Table below, and make sure the units are per hour and not per second

Junction	Flow Rate (kg/hr)	Name
J106	18,000	User 1
J107	23,000	User 2
J108	25,000	User 3
J206	25,000	User 4
J207	18,000	User 5
J208	27,000	User 6

J102, J105, J202, and J205 Bends

1. Elevation = 0 meters
2. Type = Smooth Bend
3. Angle = 90 deg.
4. $r/D = 1.5$

Note: The arrangement of the pipes on the Detailed tee junctions is important. Be certain that the inlet, outlet, and branch pipes are assigned appropriately.

J101, J103, J104, J201, J203, and J204 Tees

1. Elevation = 0 meters
2. Loss Model = Simple
3. Optional tab: Initial Pressure = 7 barG

Note: Sometimes adding initial guesses to pipes or junctions can help difficult solutions converge.

D. Check if the pipe and junction data is complete

Check the Model Status light in the bottom-right of the Quick Access Panel. A green light at this point indicates a fully defined model. A red light indicates undefined pipes or junctions in the model. If this happens,

go back to the incomplete pipes or junctions and enter the missing parameters. Alternatively, open the List Undefined Objects window from the View menu to see the undefined objects.

GSC Step 3. Create a scenario for the GSC Case

Create a new scenario from the Base Scenario for the GSC Case by either right-clicking on the Base Scenario or using the Create Child button in the Scenario Manager.

GSC Step 4. Activate the GSC Module

Open the Analysis Setup window and go the Modules panel under the Modules group. Activate the GSC module by selecting Activate GSC as is shown in Figure 5.2.

Though the module is activated, you have the option to use or ignore it. This is helpful if you want to check the impact of changes in your system configuration or in troubleshooting the model without solving for the variables. For the module's features to be used in the simulation calculations, set the GSC module to Use under the Activate GSC checkbox (Figure 5.2). The Use and Ignore options can also be toggled from the Goal Seek & Control item in the Analysis menu.

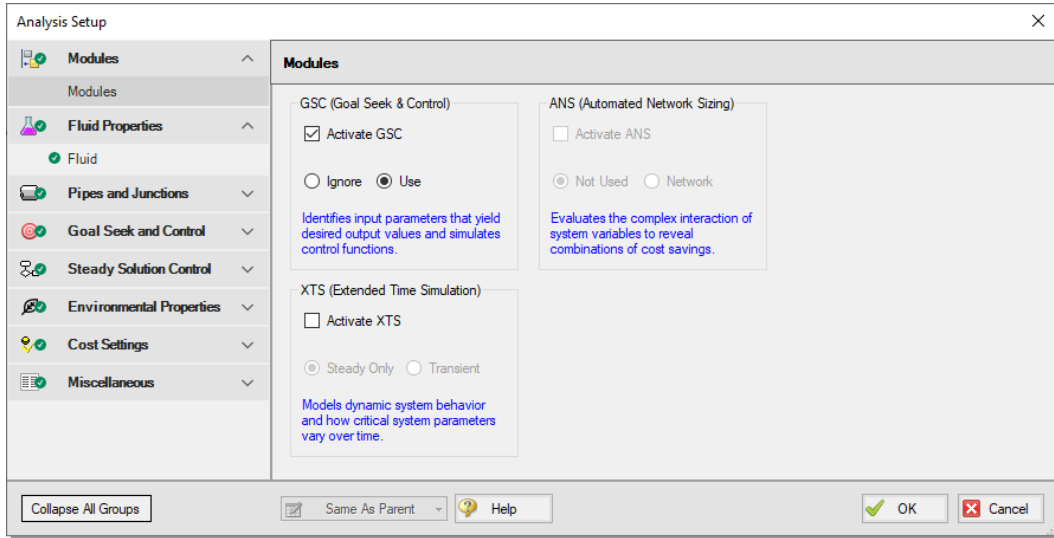

Figure 5.2 Activating the GSC module and setting it to be used in AFT Arrow

GSC Step 5. Goal Seek and Control group

When the GSC module is activated, the Goal Seek and Control group appears in the Analysis Setup window with the Variables, Goals, and Numerical Controls panels.

The Goal Seek and Control settings are specified by entering data for variables and goals in the Goal Seek and Control group panels. Go to the Variables panel as shown in Figure 5.3 below.

GSC Step 6. Add the variables

In the GSC module, variables are the parameters that AFT Arrow will modify in order to achieve the specified goals. To obtain a unique answer, there should be one variable applied for each goal. You may define as many variables and goals as you wish.

The Variables panel allows users to create and modify the system variables. Additionally, you can elect to apply certain variables while omitting others using the check box in the Apply column.

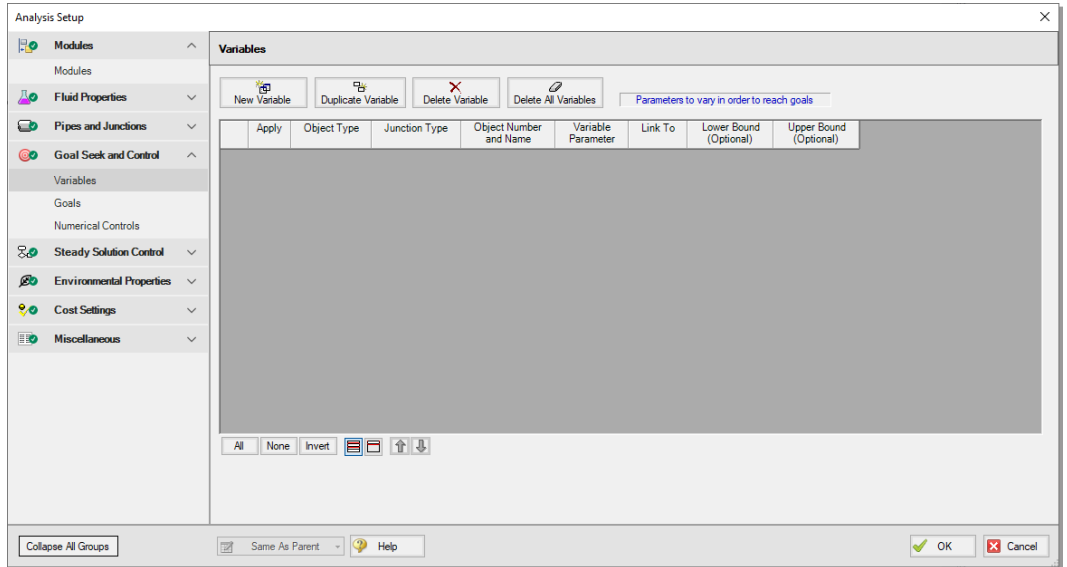

Figure 5.3 The Goal Seek and Control group is used to define GSC Variables and Goals

For this example, we want to find the supply pressures that will give us a specific minimum discharge pressure. Select the “New Variable” button, and input the following variable specifications:

1. Apply = checkbox enabled
2. Object Type = Junction
3. Junction Type = Tank
4. Object Number and Name = J1 (Boiler 1)
5. Variable Parameter = Pressure
6. Link To = (None)
7. Lower and Upper Bounds = leave blank

The Apply column allows users to specify which of the variables that have been defined will be used. This allows the flexibility of creating multiple variable cases, while only applying selected variables for any given run.

The Link To column allows users to apply the same variable to multiple objects. This allows users to force parameters for several objects to be varied identically.

Upper and lower bounds provide limits during the goal search. This can help convergence when a logical extreme is known, but can also hurt convergence if an unrealistic bound is entered and artificially restricts the solution.

Linking variables

This process steam system has two boilers to supply steam to the users. We have defined a variable for the first boiler, but we have not yet accounted for the second boiler.

For this example, the discharge pressures will be defined as a single Group Max/Min goal. However, if we define the second boiler as another independent variable, this would create only one goal for two variables.

To solve this issue, we will use variable linking. Variable linking allows you to tie multiple variables together, forcing them to be the same. To accomplish this, we will add a constraint to the problem that both of the boiler supply pressures must be the same.

Select the “New Variable” button to add the variable for the second boiler. To implement variable linking, specify J1 (Boiler 1) in the Link To column of the J2 (Boiler 2) variable. Enter the data as shown below:

1. Apply = checkbox enabled
2. Object Type = Junction
3. Junction Type = Tank
4. Object Number and Name = J2 (Boiler 2)
5. Variable Parameter = Pressure
6. Link To = J1 (Boiler 1)
7. Lower and Upper Bounds = leave blank

After entering the data, the Variables panel should appear as shown in Figure 5.4. Note the variables panel will appear undefined until at least one goal is applied.

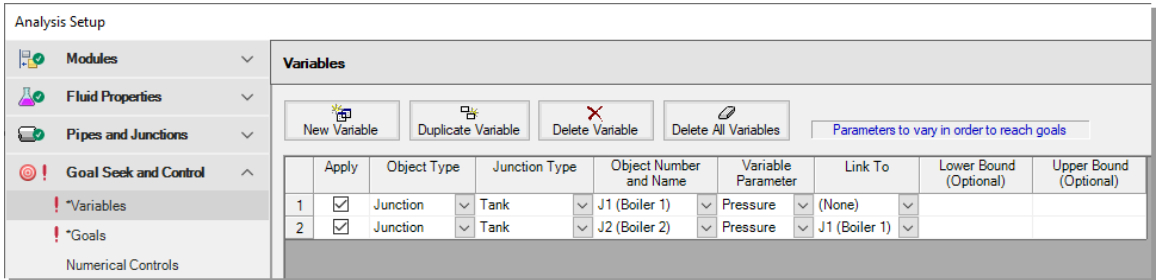

Figure 5.4 GSC Variables are parameters that are changed by AFT Arrow to achieve the defined goals

GSC Step 7. Add a goal

Goals are the parameters you want to determine. The goals are achieved as AFT Arrow modifies the variables. To obtain a unique answer, there should be one goal applied for each variable. You may define as many variables and goals as you wish.

Select the Goals panel in the Goal Seek and Control group. The Goals panel allows users to create and modify the system goals. The goal type, object type, and the goal parameter are selected. A criterion for determining if the goal has been met is then specified, along with a value and units for the goal parameter. The user then selects the object to which the goal applies and, if applicable, the location on the object at which the goal applies (e.g., the inlet or outlet of a pipe object).

For this example, we will be using a Group Max/Min goal. This type of goal allows a single goal to be applied to a group of objects. AFT Arrow applies a Group Max/Min goal by ensuring the final goal value is either greater than or equal to (Min) or less than or equal to (Max) the specified value.

For our example, a Group Max/Min goal will be applied to ensure the minimum discharge pressure at all of the assigned flow junctions is at least 7 barG.

Define a group

In order to use a Group goal, the objects that the goal applies to must be added to a Group.

To create a group, select the Groups > Create option from the Edit menu. When prompted, give the new group a name, such as “Users”, and select OK. Alternatively, you can select the Assigned Flow junctions on the Workspace using CTRL+Click before creating the groups and they will be pre-selected when the group is created.

After naming the new group, the Group Manager will be displayed. Select the new group name from the list, and then select all of the assigned flow junctions from the junction list, as shown in Figure 5.5. After choosing the assigned flow junctions, select the OK button on the Group Manager window.

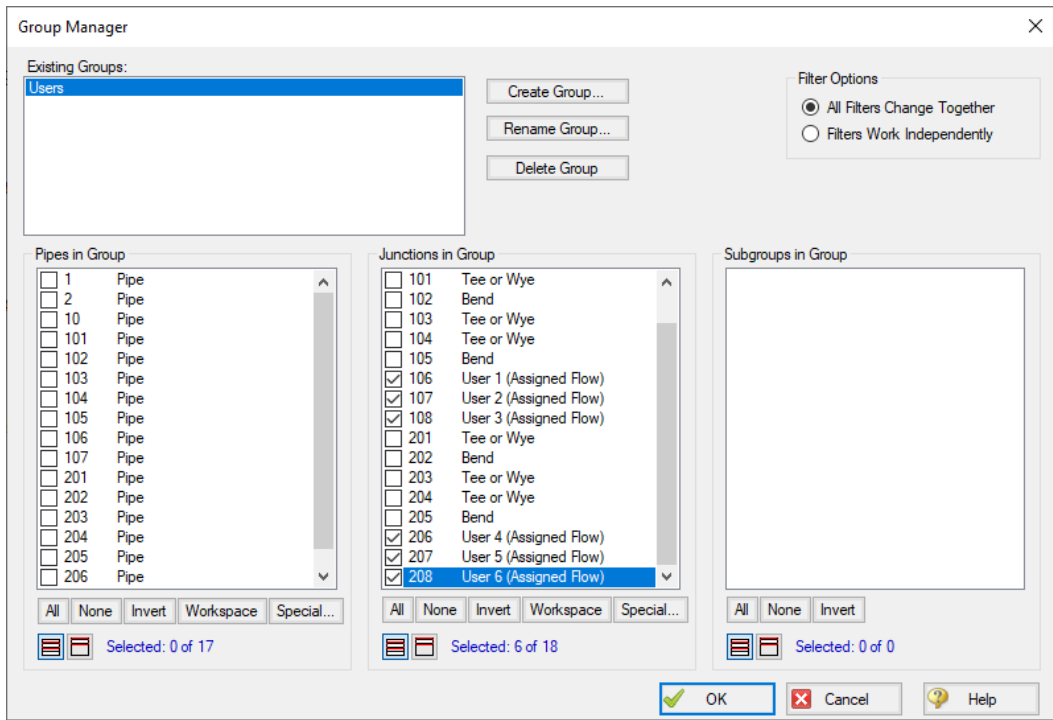

Figure 5.5 Groups are created using the Group Manager

Add a Group Max/Min goal

Now that the group has been defined, reopen the Analysis Setup window, and select the Goals panel. Add a new Goal by clicking the New Goal button, and entering the following goal specifications:

1. Apply = Checkbox enabled
2. Goal Type = Group
3. Object Type = Group Max/Min
4. Goal Parameter = Pressure Stagnation
5. Criteria = >=
6. Goal Value = 7
7. Goal Units = barG
8. Object ID = Users
9. Object Location = NA

After entering the data, the Goals tab should appear as shown in Figure 5.6.

As variables and goals are added to a model, AFT Arrow will display symbols beside the pipes and junctions that have variables or goals applied to them. The default is a “V” for variables, and a “G” for goals. This is illustrated in Figure 5.7.

The goal symbol is not displayed next to objects that are part of a group goal, so you will see only the “V” displayed on the Workspace for this example.

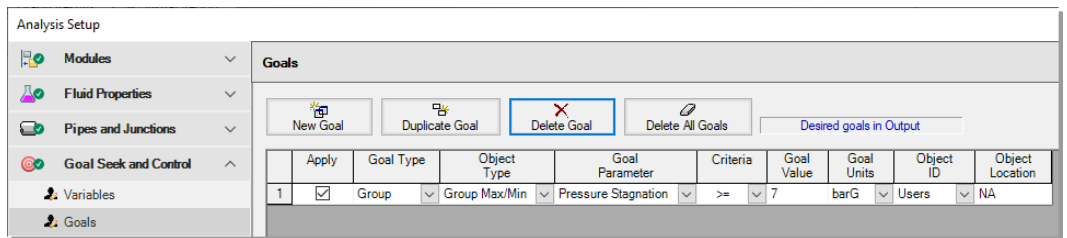

Figure 5.6 GSC Goals are the parameter values set by the user that AFT Arrow adjusts the variables to achieve

GSC Step 8. Run the model

Select “Run Model” from the Common Toolbar or in the Analysis menu. The Solution Progress window opens and begins iterating. This

window displays the AFT Arrow Solver converging on the answer. After the Solver converges, view the results by clicking Output at the bottom of the Solution Progress window.

When using the GSC module, there is a new area displayed in Solution Progress that shows the specific progress of the GSC module. As it makes progress, the Best (Lowest) value will decrease towards zero. The field in the far right displays how many complete hydraulic solutions have been run.

After completion click the Output button at the bottom of the Solution Progress window.

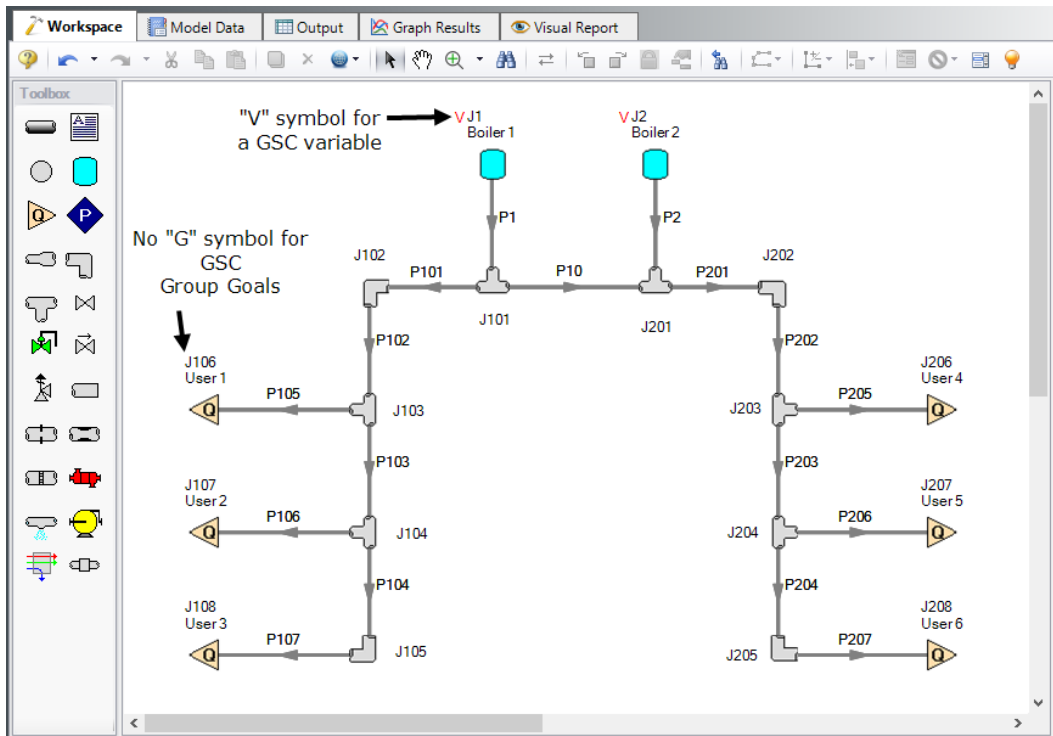

Figure 5.7 AFT Arrow displays symbols next to objects on the Workspace that have goals or variables defined (unless it is a group goal)

GSC Step 9. Examine the results

The results of the GSC analysis are shown in the General Output section.

The GSC Variables tab shows the final values for the variable parameters, as shown in Figure 5.8. The GSC Goals tab shows the values achieved for the goals, as shown in Figure 5.9.

GSC analysis summary

The GSC module analysis determined the supply pressure required to deliver a minimum pressure of 7 barG at all of the users is 20.02 barG at the boilers. Note that, because the variable for the J2 Boiler pressure was linked to the J1 Boiler variable, the final variable results for both are identical.

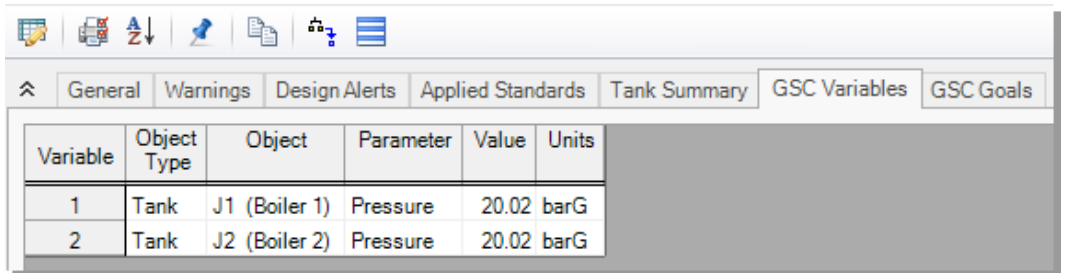

Variable	Object Type	Object	Parameter	Value	Units
1	Tank	J1 (Boiler 1)	Pressure	20.02	barG
2	Tank	J2 (Boiler 2)	Pressure	20.02	barG

Figure 5.8 The final GSC Variable values are shown on the GSC Variables tab in the General Output section

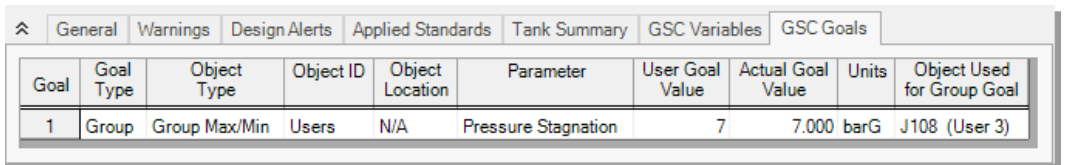

Goal	Goal Type	Object Type	Object ID	Object Location	Parameter	User Goal Value	Actual Goal Value	Units	Object Used for Group Goal
1	Group	Group Max/Min	Users	N/A	Pressure Stagnation	7	7.000	barG	J108 (User 3)

Figure 5.9 The final GSC Goal values are shown on the GSC Goals tab in the General Output section

XTS Problem statement

An initially unpressurized tank is being charged with compressed air for use in a compressed air system. The compressed air tank needs to be charged to a pressure of 8.5 barG.

An actively cooled positive displacement compressor rated for 170 sm^3/h is used in the system with an aftercooler which is sized to cool the air to 30 deg. C. The cooler has a pressure drop of 20 kPa at 170 sm^3/h . There is an isolation valve at the air receiver tank inlet to control flow out of the tank during normal operations with a Cv of 50 and Xt of 0.7.

Atmospheric air is assumed to be dry, with an ambient temperature of 21 deg. C. Determine the time it will take to charge the air receiver tank for this process.

XTS Step 1. Activate the XTS Module

Open the Analysis Setup window and go the Modules panel under the Modules group. Activate the XTS module by selecting “Activate XTS” as is shown in Figure 5.10.

Though the module is activated, you have the option to set the analysis to Steady Only or Transient. This is helpful to check the steady state results for the model without running the transient simulation. To run the Transient analysis, set the XTS module to Transient under the Activate XTS checkbox (Figure 5.10). The Steady Only and Transient options can also be toggled from the Time Simulation item in the Analysis menu.

When the XTS module is activated a new group will appear in Analysis Setup titled Transient Control.

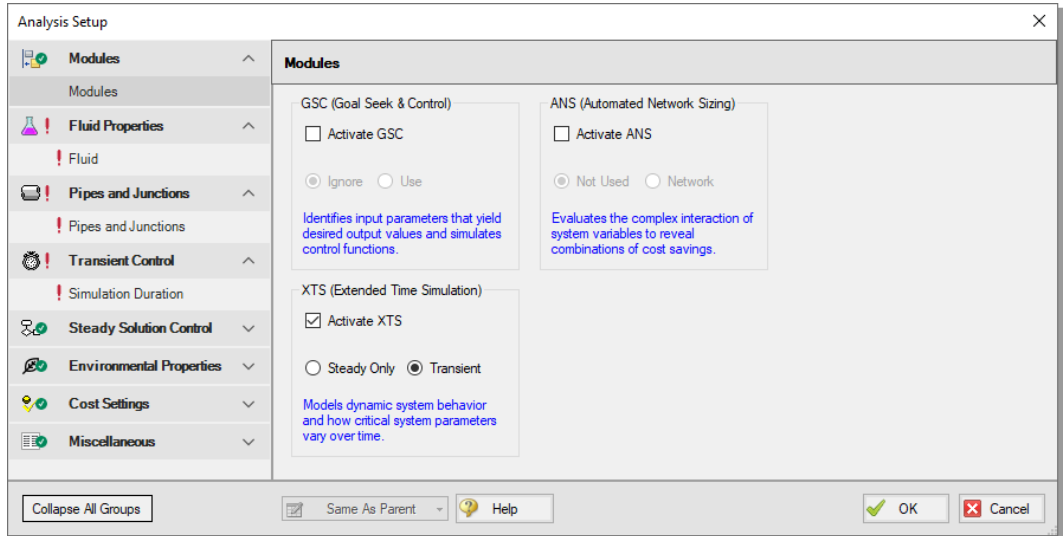

Figure 5.10 Activating the XTS module and setting the simulation type to Transient

XTS Step 2. Define the simulation duration

XTS module transient simulations are controlled through the Simulation Duration panel. You can access the Simulation Duration panel by selecting Transient Control from the Analysis menu, navigating to the Simulation Duration item in Analysis Setup, or by clicking the Simulation Duration shortcut on the Common Toolbar. When the time simulation mode is set to Steady Only, AFT Arrow will ignore the input in the Simulation Duration panel. When AFT Arrow is set to perform a transient analysis, the Transient Control group becomes a required item before the model can run.

Use the Simulation Duration panel to specify transient start and stop times, set time steps, and specify the number of output points that are saved to the output file (allows XTS to do transient calculations with a small time step while limiting the size of the data stored in the output file).

- **Set the Start Time to 0 seconds and the Stop Time as 375 seconds,** with a time step of 1 second. The output will be saved to the output file

for every time step. The Simulation Duration panel should appear as shown in Figure 5.11.

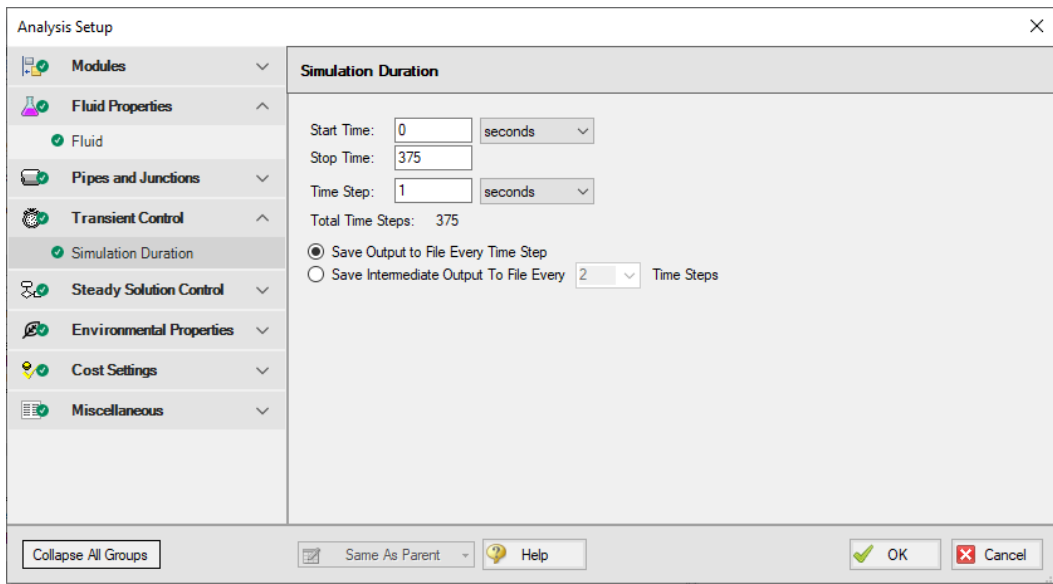

Figure 5.11 The Simulation Duration panel is used to control transient simulations

XTS Step 3. Specify fluid properties

1. In the Analysis Setup window on the Fluid panel, select the AFT Standard library, and then select “Air” in the Fluids Available in Library list
2. Click “Add to Model” to select Air for use in this model
3. Select the “Redlich-Kwong” equation of state option
4. Select the “Generalized” enthalpy model
5. Click the OK button

XTS Step 4. Build the model

A. Place the pipes and junctions

This completes the first two groups of the Analysis Setup. The Pipes and Junctions group remains undefined. To complete this group, begin by assembling the model on the Workspace as shown in Figure 5.12.

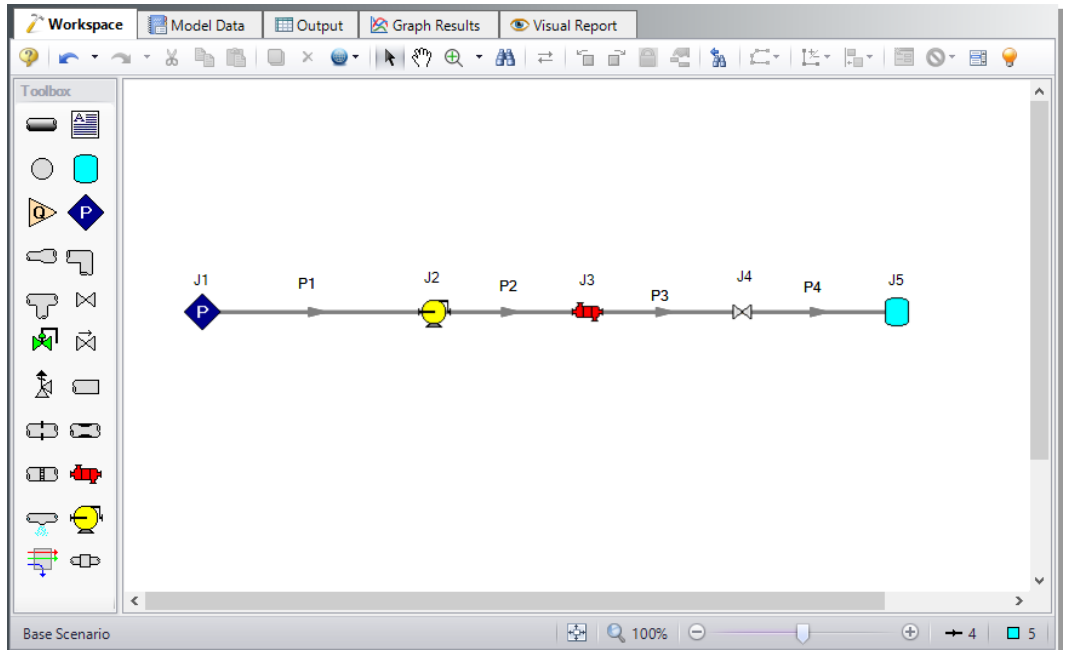

Figure 5.12 Workspace for the Air Receiver Tank Example

B. Enter the pipe data

With the objects in place, define the input data for the pipes and junctions. Double-click each pipe and enter the following data in the Properties window.

All of the pipes are Steel - ANSI, STD (Schedule 40).

Pipe	Length (meters)	Nominal Size
P1	6	3 inch
P2 - P4	3	3 inch

The AFT Arrow XTS module assumes adiabatic behavior for all pipes, so no heat transfer information is required for the pipes.

C. Enter the junction data

J1 Assigned Pressure

1. Elevation = 0 meters
2. Fluid = Air
3. Stagnation Pressure = 0 barG
4. Stagnation Temperature = 21 deg. C

J2 Compressor

1. Elevation = 0 meters
2. Compressor Model = Positive Displacement Compressor
3. Compression Process Thermodynamics = Polytropic
4. Polytropic Constant = 1.2
5. Compressor Sizing Parameter = Mass Flow Rate
6. Fixed Flow Rate = 170 sm³/h

Note: The polytropic constant entered for the compressor is intended to represent an active cooling element in the compressor.

J3 Heat Exchanger

1. Elevation = 0 meters
2. Enter Loss Model Data as follows:
 - a. Select the Loss Model as "Resistance Curve", and then click the "Enter Curve Data" button
 - b. Select the "Flow Parameter" as "Mass" with units of "sm³/h"
 - c. Enter 170 sm³/h and 20 kPa in the Raw Data table
 - d. Click the "Fill As Quadratic" button to create data for a quadratic loss curve

- e. Select "Generate Curve Fit Now" to create a quadratic curve fit, then click OK to close the Heat Exchanger Loss Curve Fit window
3. Enter Thermal Data as follows:
 - a. Thermal Model = Controlled Downstream Temperature
 - b. Controlled Outlet Temperature = 30 deg. C

Note: The controlled downstream temperature is used to simplify the inputs for this example. For a more realistic analysis one of the cross-flow models could be used.

J4 Valve

1. Elevation = 0 meters
2. Loss Source = User Specified
3. Loss Model = Cv
4. Cv = 50
5. Xt = 0.7

J5 Tank

The tank junction in the AFT Arrow XTS module can be modeled as finite in order to calculate the changes in pressure, temperature, and mass in the tank over time. Define the air receiver tank using the Finite Tank Model as follows (Figure 5.13):

1. Elevation = 0 meters
2. Tank Model = Finite
3. Initial Conditions:
 - a. Pressure = 0 barG
 - b. Temperature = 21 deg. C
4. Finite Tank Parameters:
 - a. Fixed Volume = 1900 liters
 - b. Thermodynamic Process = Isothermal

Tank Properties

Number: 5

Name: Tank

Library Jct:

Copy Data From Jct...:

Elevation: 0 meters

Tank Model | Optional | Design Alerts | Notes | Status

Tank Model

Infinite

Finite

Fluid: Air

Initial Conditions

Pressure: 0 barG

Temperature: 21 deg. C

Finite Tank Parameters

Fixed Volume: 1900 liter

Initial Conditions

Calculate From Steady State

Known

Thermodynamic Process

Adiabatic

Isothermal

Known Heat and Volume vs. Time

OK

Cancel

Jump...

Help

Figure 5.13 Properties window for the Tank junction defined as a Finite Tank

XTS Step 5. Set Up the Compressor Transient

In the XTS module, you can define transients for junctions. These transients include events such as valves opening and closing and compressors starting and shutting down. Transients for junctions are defined as either time-based or event-based transients. A time-based transient starts at a specified absolute time. Event based transients initiate when a defined criteria, such as a specified pressure in a particular pipe is reached. There are three types of event transients for junctions: single event, dual event cyclic, and dual event sequential. Single event transients are events that occur only once in a simulation. Dual cyclic events are two transient events that repeat one after the other as many times as the event trigger occurs during a simulation (such as a

valve closing then reopening). Dual sequential events are two transient events which occur one after the other, without repeating.

For this example, set a single event-based transient on the compressor so the compressor will shut off over 30 seconds when the pressure at the tank inlet reaches 8.5 barG.

- **Open the Compressor Properties window** for the J2 Compressor and navigate to the Transient tab. Under Initiation of Transient, select Single Event and enter the Transient data as shown below in Figure 5.14.

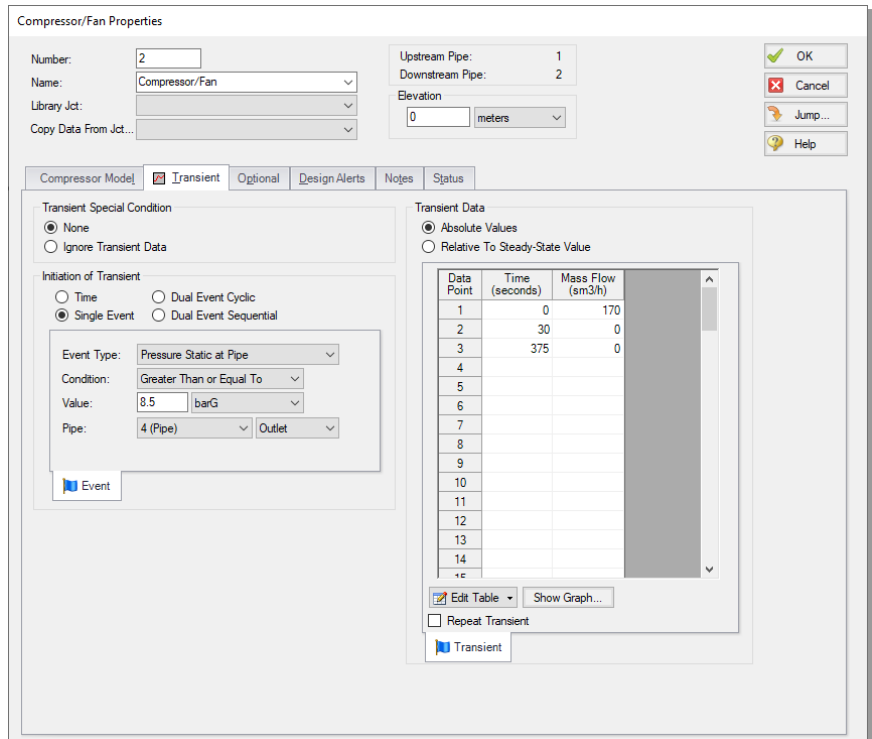

Figure 5.14 Compressor junction Transient tab with an event-based flow transient defined

XTS Step 6. Run the model

After defining all of the pipe and junction transient data and transient control items, the transient model can run. Click Run Model from the Common Toolbar or Analysis menu.

When using the XTS module, the Solution Progress window displays the progress through the transient analysis. This information is displayed below the solution tolerance data.

After the run finishes, view the results by clicking the Output button.

XTS Step 7. Examine Transient Results

The AFT Arrow XTS module displays transient output in a number of places in the Output window, as shown in Figure 5.15.

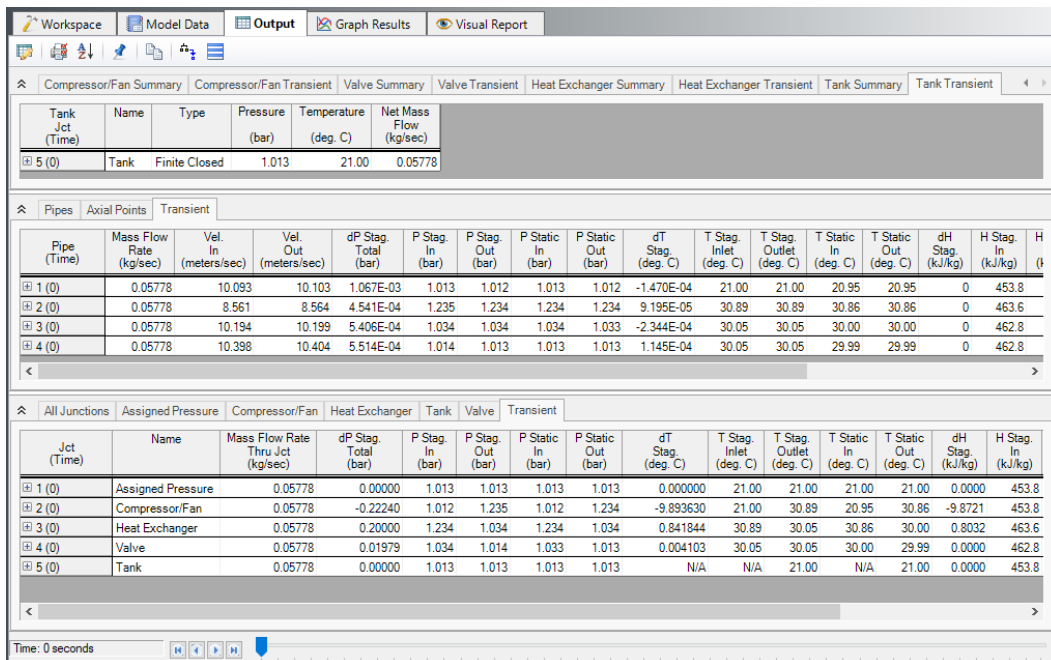

Figure 5.15 Transient output is displayed in the Output window

Each of the summary tables in the General Output section has a companion transient summary tab which displays the summary data at each time step in the transient run. The transient summary data for each junction may be expanded or collapsed by clicking the + or – sign beside the junction data list. Figure 5.16 shows the Tank Transient summary tab, with all of the data sets collapsed. Figure 5.17 shows the Tank Transient summary tab, with the data for the J5 Tank expanded.

The screenshot shows a software interface with five tabs: 'Valve Transient', 'Heat Exchanger Summary', 'Heat Exchanger Transient', 'Tank Summary', and 'Tank Transient'. The 'Tank Summary' tab is active. Below the tabs is a table with the following data:

Tank Jct (Time)	Name	Type	Pressure (bar)	Temperature (deg. C)	Net Mass Flow (kg/sec)
5 (0)	Tank	Finite Closed	1.013	21.00	0.05778

Figure 5.16 Transient Summary tabs are displayed in the General Output section

The screenshot shows the same software interface as Figure 5.16, but the 'Tank Summary' table is expanded to show data for every time step from 0 to 8. The data is as follows:

Tank Jct (Time)	Name	Type	Pressure (bar)	Temperature (deg. C)	Net Mass Flow (kg/sec)
5 (0)	Tank	Finite Closed	1.013	21.00	0.05778
5 (1)	Tank	Finite Closed	1.040	21.00	0.05778
5 (2)	Tank	Finite Closed	1.065	21.00	0.05778
5 (3)	Tank	Finite Closed	1.091	21.00	0.05778
5 (4)	Tank	Finite Closed	1.117	21.00	0.05778
5 (5)	Tank	Finite Closed	1.142	21.00	0.05778
5 (6)	Tank	Finite Closed	1.168	21.00	0.05778
5 (7)	Tank	Finite Closed	1.193	21.00	0.05778
5 (8)	Tank	Finite Closed	1.219	21.00	0.05778

Figure 5.17 Transient Summary data can be expanded to show the junction data for every Time Step

The Event Message tabs in the General Output section (Figure 5.18) can be used to see when events are triggered during the transient. For this example, the Event Messages By Jct tab shows that the flow transient at the compressor was triggered at 333 seconds into the transient, meaning it took 333 seconds to pressurize the tank to the required pressure.

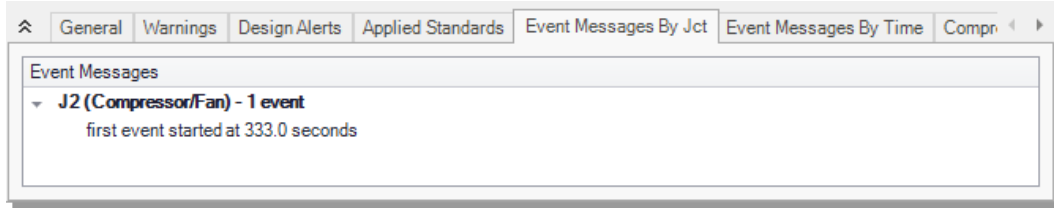

Figure 5.18 Event Messages By Jcn tab in the General section of the Output window

The Quick Graph feature can be used to conveniently plot transient data for rapid examination in any of the transient Output sections. To use the Quick Graph feature, place the mouse cursor over one of the cells of data in the column you wish to examine. Then, right-click with the mouse, and select Quick Graph from the list. Figure 5.19 illustrates how to generate a Quick Graph in the General Output section for the J5 Tank Pressure vs. Time. The graph illustrates how the pressure in the tank rises over time and steadies out at about 9.9 bar once the compressor fully shuts off (Figure 5.20). The Graph Results window may also be used to create a full range of graphs related to the XTS module transient output.

Tank Jct (Time)	Name	Type	Pressure (bar)	Temperature (deg. C)	Net Mass Flow (kg/sec)
5 (0)	Tank	Finite Closed	1.013	21.00	0.05778
5 (1)	Tank	Finite Closed			
5 (2)	Tank	Finite Closed			
5 (3)	Tank	Finite Closed			
5 (4)	Tank	Finite Closed			
5 (5)	Tank	Finite Closed			
5 (6)	Tank	Finite Closed			
5 (7)	Tank	Finite Closed			
5 (8)	Tank	Finite Closed	1.219	21.00	0.05778
5 (9)	Tank	Finite Closed	1.245	21.00	0.05778
5 (10)	Tank	Finite Closed	1.270	21.00	0.05778
5 (11)	Tank	Finite Closed	1.296	21.00	0.05778
5 (12)	Tank	Finite Closed	1.322	21.00	0.05778
5 (13)	Tank	Finite Closed	1.347	21.00	0.05778
5 (14)	Tank	Finite Closed	1.373	21.00	0.05778
5 (15)	Tank	Finite Closed	1.399	21.00	0.05778
5 (16)	Tank	Finite Closed	1.424	21.00	0.05778
5 (17)	Tank	Finite Closed	1.450	21.00	0.05778

Figure 5.19 Use Quick Graph to easily plot J5 Tank pressure

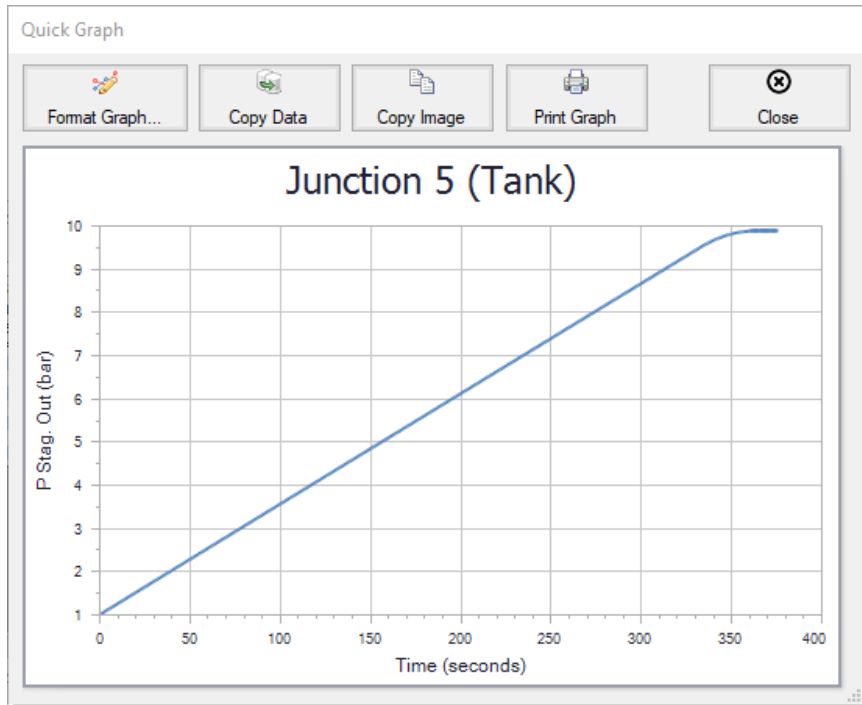

Figure 5.20 Quick Graph Plot of J5 Tank pressure

Similar to the summary transient data, the transient tabs in the Pipe and Junctions sections of the Output window (shown in Figure 5.15) are used to display the transient data for each pipe and junction at every time step. This transient data can be expanded or collapsed in the same manner as in the General Output transient summaries.

Figure 5.21 shows the output data for the pipes and junctions, found on the Pipes and All Junctions tabs, at the initial time step, Time = 0 seconds. The output for all of the pipes and junctions can be displayed at any time step by using the slider bar located at the bottom of the Output window. Figure 5.22 shows the pipe and junction data at Time = 60 seconds.

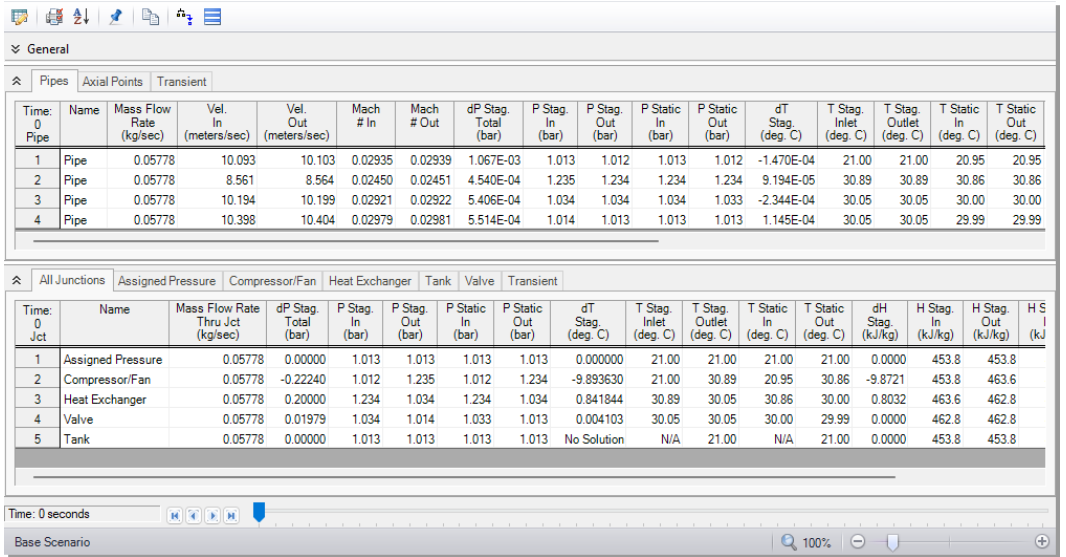

Figure 5.21 Pipe and Junction transient data at Time = 0 seconds

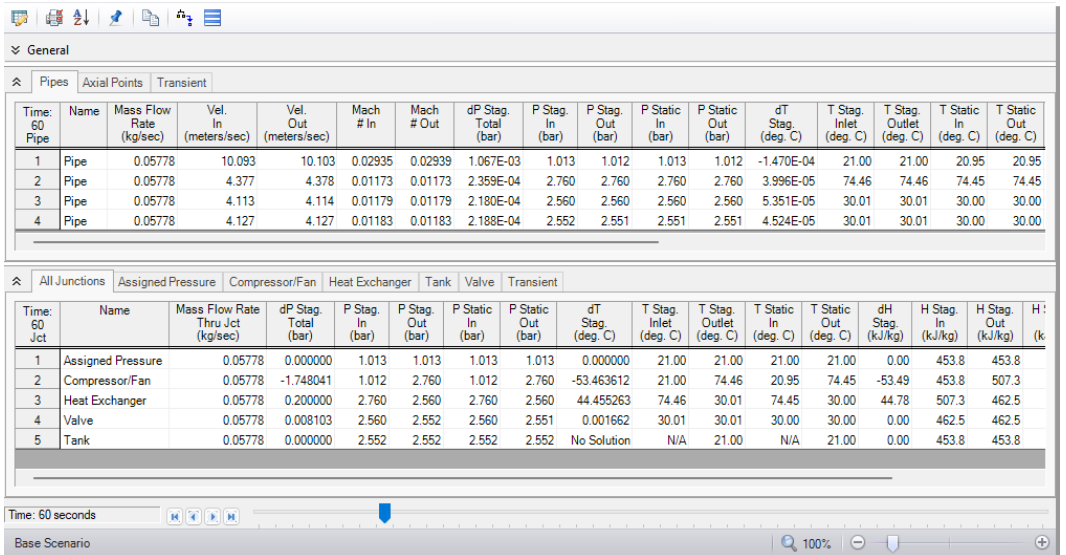

Figure 5.22 Pipe and Junction transient data at Time = 60 seconds

Other AFT Arrow Capabilities

This Quick Start Guide necessarily omitted or had brief coverage of a number of important AFT Arrow capabilities. This chapter briefly describes some of the important capabilities not covered.

You can find a number of other example model discussions on the AFT documentation help website. To view additional examples, open the Help menu and choose Show Examples or go to docs.aft.com, select the AFT Arrow Help Site, expand the Examples section in the sidebar, then select Walk-Through Examples.

Microsoft Excel™ data integration

AFT Arrow includes Excel importing and exporting. An Excel spreadsheet can be used to vary selected input parameters in multiple scenarios. Selected output can also be exported to specified Excel sheets and cells.

Integration with other software and data standards

AFT Arrow includes a number of importing and exporting capabilities. Piping layouts and dimensional data can be imported from GIS Shapefiles (*.SHP) to build a model. Additionally, CAESAR II Neutral Files (*.CII) can be imported into AFT Arrow and EPANET Files (*.INP) can be both imported and exported.

Piping Component Files (*.PCF) from AutoCAD Plant 3D, SmartPlant, PDS, CADWorx, and other software can be imported into AFT Arrow. These options are all accessed from the File Menu.

Gas mixtures using NIST REFPROP and Chempak

The NIST REFPROP and Chempak fluid libraries support gas mixing in two forms. First, users can create their own mixtures. These are called pre-mixtures because they are defined before the model is run. Second, as flow streams of different composition mix, an entirely new gas mixture results. Its composition depends on the composition of the incoming streams as well as the relative flow rates. Since in general the flow rates are not known by the user, AFT Arrow updates the composition of this new mixture as the simulation progresses. For this reason these mixtures are referred to as dynamic mixtures. AFT Arrow is restricted to non-reacting gas mixture calculations.

The ASME Steam Tables library

The ASME Steam Tables Library offers users access to fluid properties obtained from the IAPWS Industrial Formulation 1997 for the Thermodynamic Properties of Water and Steam (IAPWS-IF97). This library is selected by choosing the option at the top of the Fluid panel in Analysis Setup, at which point it is automatically displayed in the Fluids in Current Model area.

Separator junction

AFT Arrow offers a separator junction. This junction type allows you to separate fluids out of a mixture, but requires either the NIST REFPROP or Chempak fluid library to be used in the model.

Fitting library

AFT Arrow offers a library of about 400 fitting losses that can be added to pipes.

Libraries

Junction components and pipe materials can be saved to libraries for later reuse. Libraries can be located on local PCs or deployed across local or wide area networks. The Library Manager allows users to connect to relevant libraries for their specific pipe system design.

Varied pipe geometries including rectangular duct

Five different pipe geometries can be modeled in AFT Arrow. The default geometry is the cylindrical pipe. The other four geometries are the rectangular duct, the cylindrical annulus, the noncylindrical pipe, and the helical tube.

Sonic choking

AFT Arrow models sonic choking in complex pipe systems and accurately predicts the resulting choked flow rate. In addition, AFT Arrow can accurately calculate multiple choking points in the system.

Rotating systems for turbomachinery

AFT Arrow allows users to specify rotational velocities such as those experienced in turbomachinery. AFT Arrow uses this information to determine the varying acceleration body force on each individual pipe as determined by the laws of rotational dynamics.

Elevation changes

AFT Arrow uses elevation differences between junctions to calculate hydrostatic or gravity pressure changes in a system. This can be especially useful for high density gases with moderate elevation changes or pipe systems with significant elevation changes such as those found in overland natural gas pipelines, gas piping for deep mining operations, and HVAC in high rise buildings.

Relief system modeling

AFT Arrow provides support for modeling relief systems, including relief valve junctions and support for ANSI/ISA Cv loss coefficients. Sonic capabilities allow modeling of high velocity conditions often found in relief systems.

Control valve modeling

AFT Arrow can model four types of control valves. They are Pressure Reducing Valves (PRVs), Pressure Sustaining Valves (PSVs), Flow Control Valves (FCVs), and Pressure Drop Control Valves (PDCVs).

Variable speed compressors and fans

AFT Arrow allows you to model controlled compressors or fans where the control parameter is flowrate, discharge pressure, or suction pressure. The compressor or fan speed is varied to meet the setpoint.

Heat of compression

AFT Arrow allows users to choose several different compression models for compressor junctions. The compression process models how the heat of compression affects the gas temperature, which is especially important in compressor applications.

Insulation on inside of pipe/duct

Insulation can be placed on the inside of a pipe or duct, and the effect of reduced flow area on the pressure drop will be automatically determined. If modeling heat transfer, the effect of the insulation on the inside will be accounted for.

Model heat transfer between loops

Heat transfer between loops which are hydraulically isolated can be modeled. The loops can have different fluids. This is called thermal linking.

View input and output data from different scenarios concurrently

Input data from ancestor scenarios can be viewed concurrently in the Model Data window. Similarly, output data from different scenarios can be viewed concurrently in the Output window.

Compare input from different scenarios

The Scenario Comparison Tool can be used to compare pipe, junction, and general model file inputs for any number of scenarios in the model file. This allows the user to quickly identify differences between scenarios, or to generate a report on inputs for different cases.

Design Alerts

Design Alerts can be created for pipes and junctions to alert the user that one of their project constraints has been violated. A common use is maximum and minimum allowed operating pressure. If the resulting value for that parameter violates the Design Alert a warning message is given in the Output.

Cost calculations

Material, Installation, and Maintenance costs can be calculated for junctions, pipes, and fittings based on Cost Libraries which are user-created. In addition, energy (operation) costs can be calculated for compressors/fans. Time value of money can be taken into consideration by entering inflation and interest rates. The results are presented in a Cost Report in the Output.

Retaining and reproducing graphs

Comprehensive graphing features allow users to graph a wide variety of parameters at single points or along flow paths within their model. Graphs added to a Graph List are saved so that the graph can be regenerated with the same styles and customization if changes are made to the model input, or if the user desires to plot the same graph in multiple scenarios. Multiple graphs can be shown at the same time.

Index

A

- AFT Arrow
 - engineering assumptions 3
 - Overview 4
 - property data 3
 - summary of capabilities 2
- AFT Standard fluid 4
 - Database 20
- ANS Module 83
- ASME Steam Tables Library 114
- ASME Steam/Water 3
- AutoCAD Plant 3D 114

C

- CADWorx 114
- CAESAR II 113
- Change Units window 36
- Chempak 2
- Chempak fluid
 - Database 4
 - Library 20
- Chempak fluid library 2, 20
- Compression models 116
- Compressor/Fan junction 2
- Control valves 116
- Copy Data From Jct... 26, 55

D

- Defining objects
 - Checklist - Define All Pipes and Junctions 23
- Design Alerts 117
- Dual y-axis graph 63
- Duplicate 14

E

- Elevation
 - changes 115
 - relative locations of objects 14, 63
- EPANET 113
- Excel 113
- Exporting 113

F

- FCV 116
- Fitting Library 114
- Flow Control Valve 76, 116
- Fluid panel 20, 46, 76, 85, 89, 100-101
 - ASME Steam 114

G

- Global Pipe Edit 48
- Goal Seek and Control
 - Goals 93
 - Manager 90
 - Variable and goal results in Output window 97
- Variables 90

Goals

Group Goal 93-94

Group Max/Min 93-94

Graph Parameters tab 41

Graph Results window 5, 39

Gravitational pressure losses 115

Group Max/Min goal 93-94

GSC Module 83

setting up goal seeking 90

H

Heat Exchanger junction 79

Heat of Compression 116

Heat Transfer

Between different loops 117

Highlight feature 26

HVAC 115

Hydrostatic pressure losses 115

I

ID numbers 13, 23

Importing 113

Inspection feature 27

Isometric grid 69

J

Junctions 12

bend 88

compressor/fan 2, 45, 51-52, 59, 67

heat exchanger 79

separator 114

tank 24, 59, 66, 80, 87-88

tee/wye 88

valve 54, 79

L

Libraries 115

Library Manager 115

Lock 18

M

Mixtures 20, 114

Model Data window 5, 30

N

NIST REFPROP 2, 4

O

Open Pipe/Jct Window 24

Output Control window 34

Output file 32

Output window 5, 33, 97

Displaying Goal Seek and Control results 97

Overview of AFT Arrow 4

P

Parameter and Unit Preferences window 25

PCF 114

PDCV 116

PDS 114

Pipe Drawing tool 15

Pipe geometries
 cylindrical annulus 115
 cylindrical pipe 115
 helical tubes 115
 nonspherical pipes 115
 rectangular duct 115
Pipe heat transfer data 28, 59, 66, 75,
 78, 87
Pipe object 13
Pipe Properties window 28
Pipes
 flow direction 18
Pressure Drop Control Valve 116
Pressure Reducing Valve 116
Pressure Sustaining Valve 116
Primary Windows 4
Properties windows
 using tabs 26
PRV 116
PSV 116
Q
Quick Access Panel 11
 pinning 12
Quick Graph Formatting 42
R
Reference enthalpy 21
Reference positive flow direction 18
Relief Valves 116

Results Diagram
 Compressor/Fan 61
 Pipes with Heat Transfer 61
Retaining graphs 118
Reverse Direction 18
Reverse flow 18
Rotating systems 115
Rotational velocity 115
Run Model 31, 60, 68, 80, 95

S

Scenario Manager 11, 57
Separator junction 114
Show Object Status 23, 30
SmartPlant 114
Solution Progress window 31
Solver 31, 34
Sonic Area 34, 44
Sonic Choking 33, 43, 115
Stacked Graphs 41
Status Bar 19

T

Tank junction 13
Toolbars 19
Toolbox 11-12, 15
 Annotation tool 12
 Pipe Drawing Tool 12
Tooltips 12
Turbomachinery 115

U

Undefined Objects list 23

User Options 23

V

Valve junction 54

Variable speed Compressor/Fan 116

W

Workspace window 5, 11-12, 77

 Workspace Layers 37

X

XTS Module 83

AFT Arrow™ Add-on Modules



Automated Network Sizing

Evaluates the complex interaction of system variables to reveal combinations of cost savings



Extended Time Simulation

Models dynamic system behavior and how critical system parameters vary over time.



Goal Seek & Control

Identifies input parameters that yield desired output values and simulates control functions



For Product Support:

Call: (719) 686-1000

Email: support@aft.com



2955 Professional Place, Suite 301
Colorado Springs, CO 80904 USA
(719) 686 1000
info@aft.com
www.aft.com

